

SGLOCKS

Newsletter

FEBRUARY 23
ISSUE 99



NEW

Viro[®] ITALY
NOW IN
AUSTRALIA

NEW

MLAA/SGLOCKS
NATIONAL
ROADSHOW

NEW

JMA[®]
FIXED CODE
CLONING REMOTE



Established in 1942, the Viro brand has become synonymous with quality all over the world. In 2023 Viro celebrates its 81st birthday with more than 100 staff that are involved in the creation of first-rate items, controlling quality and devoting themselves to the constant innovation of Viro Products.



Scan to see our current **Viro** range



NOTE:
Measured from housing end to middle of screw hole



Offset Euro Cylinder - 35mm / 40mm

Art Id.	Description	Profile	Price
920-6	'Brass' Offset Euro Cylinder 35/40mm with Universal Cam, Includes 3x Keys & Screw	JMA - CI-DL Silca - CS206	CFP
920-16-9	'Nickel Silver ' Euro Cylinder 35/40mm with DIN (30° Cam), Includes 3x Keys & Screw	JMA - CI-DL Silca - CS206	CFP

Check sglocks.com.au For Pricing!



Offset Euro Cylinder - 35mm / 45mm

Art Id.	Description	Profile	Price
920-17	'Brass' Euro Cylinder 35/45mm with Universal Cam, Includes 3x Keys & Screw	JMA - CI-DL Silca - CS206	CFP

Check sglocks.com.au For Pricing!



Offset Euro Cylinder - 30mm / 60mm

Art Id.	Description	Profile	Price
920-9	'Brass' Euro Cylinder 30/60mm with Universal Cam, Includes 3x Keys & Screw	JMA - CI-DL Silca - CS206	CFP

Check sglocks.com.au For Pricing!

Offset Euro Cylinder - 35mm / 55mm



Art Id.	Description	Profile	Price
920-19	'Brass' Euro Cylinder 35/55mm with Universal Cam, Includes 3x Keys & Screw	JMA - CI-DL Silca - CS206	CFP

Check
sglocks.com.au
 For Pricing!

Extended Euro Cylinder - 45mm / 45mm



Art Id.	Description	Profile	Price
920-32	'Brass' Euro Cylinder 45/45mm with Universal Cam, Includes 3x Keys & Screw	JMA - CI-DL Silca - CS206	CFP

Check
sglocks.com.au
 For Pricing!

Offset Euro Cylinder - 30mm / 70mm



Art Id.	Description	Profile	Price
920-11	'Brass' Euro Cylinder 30/70mm with Universal Cam, Includes 3x Keys & Screw	JMA - CI-DL Silca - CS206	CFP

Check
sglocks.com.au
 For Pricing!

Offset Euro Cylinder - 45mm / 55 mm



Art Id.	Description	Profile	Price
920-34	'Brass' Euro Cylinder 45/55mm with Universal Cam, Includes 3x Keys & Screw	JMA - CI-DL Silca - CS206	CFP

Check
sglocks.com.au
 For Pricing!

Extended Euro Cylinder - 50mm / 50mm



Art Id.	Description	Profile	Price
920-35-9	'Nickel Pl' Euro Cylinder 50/50mm with DIN (30° Cam), Includes 3x Keys & Screw	JMA - CI-DL Silca - CS206	CFP

Check
sglocks.com.au
 For Pricing!

Offset Euro Cylinder - 30mm / 80mm



Art Id.	Description	Profile	Price
920-12-9	'Nickel Pl' Euro Cylinder 30/80mm with DIN (30° Cam), Includes 3x Keys & Screw	JMA - CI-DL Silca - CS206	CFP

Check sglocks.com.au For Pricing!

Offset Euro Cylinder - 40mm / 70mm



Art Id.	Description	Profile	Price
920-30-9	'Nickel Pl' Euro Cylinder 40/70mm with DIN (30° Cam), Includes 3x Keys & Screw	JMA - CI-DL Silca - CS206	CFP

Check sglocks.com.au For Pricing!

Offset Euro Cylinder - 30mm / 90mm



Art Id.	Description	Profile	Price
920-13	'Brass' Euro Cylinder 30/90mm with Universal Cam, Includes 3x Keys & Screw	JMA - CI-DL Silca - CS206	CFP

Check sglocks.com.au For Pricing!

Offset Euro Cylinder - 45mm / 75mm



Art Id.	Description	Profile	Price
4703-75-45	'Nickel Pl' Euro Cylinder 45/75mm with DIN (30° Cam), Includes 3x Keys & Screw	JMA - VI-8D Silca - VI3	CFP

Check sglocks.com.au For Pricing!

Offset Euro Cylinder - 45mm / 85mm



Art Id.	Description	Profile	Price
4703-85-45	'Brass' Euro Cylinder 45/85mm with Universal Cam, Includes 3x Keys & Screw	JMA - VI-8D Silca - VI3	CFP

Check sglocks.com.au For Pricing!

Light Duty Roller Shutter Lock - 'Loose Pin'

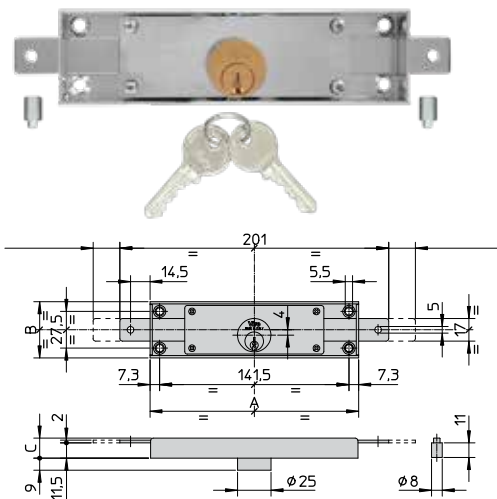

PRODUCT SPECIFICATION

- Case Depth (Thickness) : 15mm
- Dimensions : 156 x 42mm
- Lock Cylinder: Central , Solid Brass, brass pins, mushroom brass counterpins, pick-resistant, phosphor bronze pin springs.
- Bolt Projection: 20mm
- Symmetric profile nickel-plated brass key, operating from both outside and inside
- Key Profile; JMA VI-7, SILCA VI13
- Loose pins
- Structure and internal components: galvanized steel



Art. **8241**

Heavy Duty Roller Shutter Lock - 'Loose Pin'

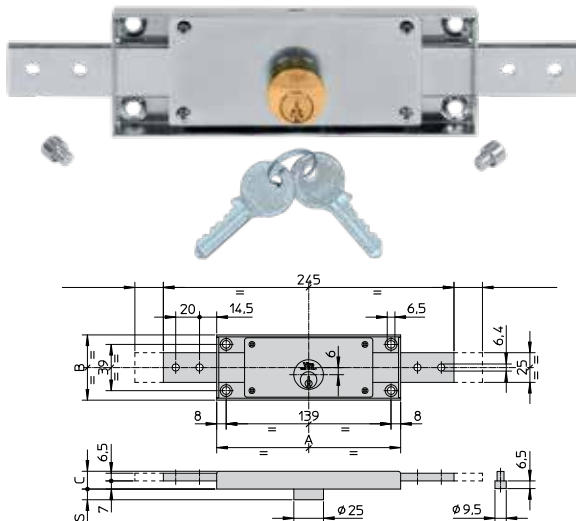

PRODUCT SPECIFICATION

- Case Depth (Thickness): 15mm
- Dimensions :155 x 55mm
- Lock Cylinder: Central , Solid Brass 9mm projection, brass pins, mushroom brass counterpins, pick-resistant, phosphor bronze pin springs.
- Bolt Projection: 24mm
- Bolt thickness: 2mm thick - folded to give overall 6.5mm thickness
- Symmetric profile nickel-plated brass key, operating from both outside and inside
- Key Profile; JMA VI-7, SILCA VI13
- Loose pins
- Structure and internal components: galvanized steel



Art. **8231-9**

Heavy Duty Roller Shutter Lock - 'Fixed Pin'

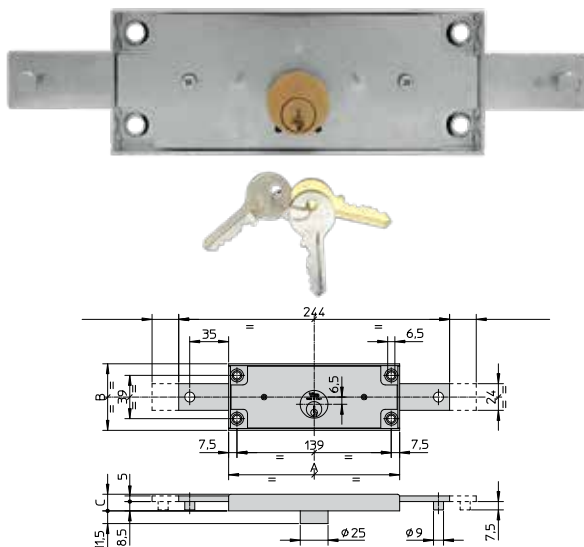

PRODUCT SPECIFICATION

- Case Depth (Thickness) : 15mm
- Dimensions :154 x 59mm
- Lock Cylinder: Central , Solid Brass 11.5mm projection, brass pins, mushroom brass counterpins, pick-resistant, phosphor bronze pin springs.
- Bolt Projection: 24mm
- Bolt thickness: 2x 2.5mm thick (5mm Overall)
- Supplied with 2x Outside nickel plated brass keys + 1x Inside satin brass key.
- Key Profile External : JMA VI-1D, SILCA VI081
- Key Profile Internal : JMA VI-1I, SILCA VI080
- Loose pins
- Structure and internal components: galvanized steel



Art. **8201**



SGLOCKS NATIONAL ROADSHOW



- *GREAT FOOD & DRINKS*
- *GREAT PRODUCTS*
- *GREAT PRIZES*
- *GREAT COMPANY*



1 NSW Wednesday
8th of March

2 QLD Friday
10th of March

3 VIC Wednesday
15th of March

4 SA Wednesday
22nd of March

5 WA Friday
24th of March

1



NSW Wednesday
8th of March

**One Drop
Brewing Co**

5 Erith St,
Botany
NSW 2019



2



QLD Friday
10th of March

**Stone & Wood
Brewery**

99 Bridge St,
Fortitude Valley
Brisbane 4006



3



VIC Wednesday
15th of March

CBCo Brewery

89 Bertie St,
Port Melbourne
VIC 3207



4



SA Wednesday
22nd of March

**Bowden
Brewery**

Plant 3,
12 Fourth St,
Bowden
SA 5007



5



WA Friday
24th of March

**The Dutch
Trading Co**

243 Albany Hwy,
Victoria Park,
WA 6100



MORTICE LOCK KITS

NEW ADDITIONS TO THE KIT RANGE



DOUBLE CYLINDER KIT - 60mm Backset

The LOCKTON 60mm Mortice Lock KIT 4 (DOUBLE CYLINDER) contains a LOCKTON 60mm Backset Mortice Lock, Oval Cylinders and suitable furniture.

Kit contains:

- 1 x 60mm Mortice Lock (Art. SG-ML60)
- 1 x External Lever with Cylinder Hole (Art. ID: SQ-01C-25-SCP)
- 1 x Internal Lever with Cylinder Hole (Art. ID: SQ-01V-25-SCP)
- 2 x Keyed Alike Oval Cylinders (Art. ID: 410-SC-KA1)

Art. ID **ML60-KIT4**



DISABILITY KIT - 60mm Backset

The LOCKTON 60mm Mortice Lock KIT 5 (DISABILITY) contains a LOCKTON 60mm Backset Mortice Lock, Oval Cylinder and suitable furniture.

Kit contains:

- 1 x 60mm Mortice Lock (Art. ID: SG-ML60)
- 1 x External Lever with Cylinder Hole (Art. ID: SQ-01C-25-SCP)
- 1 x Internal Lever with DA Turn Snib (Art. ID: SQ-13VDA-25-SCP)
- 1 x Oval Cylinder (Art. ID: 410-SC)

Art. ID **ML60-KIT5**



DOUBLE CYLINDER KIT - 23mm Backset

This is a Kit that contains a 23mm Backset Mortice Lock, Oval Cylinders and Suitable furniture for use in "Double Cylinder" configuration.

Kit contains:

- 1 x 23mm Narrow Stile Mortice Lock (Art. ID: SG-SBML23)
- 1 x External Lever with Cylinder Hole (Art. ID: NSQ-01C-25-SCP)
- 1 x Internal Lever with Cylinder Hole (Art. ID: NSQ-01V-25-SCP)
- 2 x Oval Cylinder (Art. ID: 410-SC-KA1)

Art. ID **SBML23-KIT4**



DISABILITY KIT - 23mm Backset

This is a Kit that contains a 23mm Backset Mortice Lock, Cylinder and Suitable furniture for use in "Disability" configuration.

Kit contains:

- 1 x 23mm Narrow Stile Mortice Lock (Art. ID: SG-SBML23)
- 1 x External Lever with Cylinder Hole (Art. ID: NSQ-01C-25-SCP)
- 1 x Internal Lever with Disability Turn Snib (Art. ID: NSQ-13VDA-25-SCP)
- 1 x Oval Cylinder (Art. ID: 410-SC-KD)

Art. ID **SBML23-KIT5**



Round End Kits available in all configurations



LOCKTON

Commercial Mortice Lock

60mm Backset

Art. ID **SG-ML60**

Check

sglocks.com.au

For Pricing!

Suitable for use in all heavy traffic areas including:

- Commercial
- Education
- Retail
- Industrial
- Medical



60mm Backset Mortice Lock - Deadbolt

Art. ID **SG-ML60-DB**

60mm Backset Mortice Lock - Sliding

Art. ID **SG-ML60-SLD**

5 Year Warranty



4- Hour Fire Rating



Art. ID **SQ-01C-25-SCP**
External Square Plate with Cylinder Hole & Lever



Art. ID **SQ-01V-25-SCP**
Internal Square Plate with Cylinder Hole & Lever



Art. ID **SQ-02C-25-SCP**
External Square Plate with Lever Only



Art. ID **SQ-02V-25-SCP**
Internal Square Plate with Lever Only



Art. ID **SQ-04C-SCP**
External Square Plate with Cylinder Hole Only



Art. ID **SQ-04V-SCP**
Internal Square Plate with Cylinder Hole Only



Art. ID **SQ-13VDA-25-SCP**
Internal Square Plate with DA Turn Snib & Lever



Art. ID **SQ-13V-25-SCP**
Internal Square Plate with Turn Snib & Lever



Art. ID **SQ-53C-25-SCP**
External Square Plate with Emergency Turn Indicator & Lever



Art. ID **SQ-03C-25-SCP**
External Square Plate with Emergency Turn & Lever



Art. ID **SQ-06VDA-SCP**
Internal Square Plate with DA Turn Snib only

RANGE DESCRIPTION
Suits Art. ID SG-ML60 & retrofits most 60mm Australian Mortice Locks

RANGE SPECIFICATION

- Material: Solid Brass (Body & Handle)
- Handing: Easy change handing
- Quality Return Spring



ROUND END FURNITURE
FULL RANGE ALSO AVAILABLE



Economical FIXED CODE Universal Remote

NEW



PRODUCT DESCRIPTION

JMA Art. M-LT Fixed Code Duplicating Remote - Scan QR Code (Right) to see how simple duplicating remotes can be.

Capable of cloning and duplicating a wide range of FIXED code remotes with 433 Mhz frequency.

Capable of integrating codes for 4 different original remotes on 1 device.



SCAN to see how simple duplicating remotes can be

PRODUCT SPECIFICATIONS

- 4-Buttons
- Frequency: 433 Mhz
- Battery Type: Coin Battery (CR2032)

Art ID: M-LT



Dedicated TRI-CODE remote PTX5 and B&D

PRODUCT DESCRIPTION

JMA M-TC TRI-CODE Universal remote, is a compact, durable remote that is compatible with ATA Triocode and B&D Tri-Tran Garage & Gate Motors.

The MT-C comes with a Pre-coded default coding type to suit ATA TrioCode Remotes.

The MT-C Can easily be converted to a B&D Remote by:

Holding down the top 2 x buttons (1&2) on the MT-C Remote. The LED will turn on, After 4 seconds, LED will Turn Off

Release the buttons, The coding has now been switched successfully

The remote is registered into the ATA or B&D receiver using the factory manual procedure



Art ID: M-TC



PRODUCT SPECIFICATIONS

- 4-Buttons
- Frequency: Triple Frequency.433.92, 433.47 & 434.37
- Replaces PTX5 and B&D Tri-Tran Remotes
- Battery Type: Coin Battery (CR2032)

Replaces below:



PTX5v2

062731

Multi-purpose FIXED & ROLLING CODE Universal Remote

PRODUCT DESCRIPTION

- The M-BT remote control duplicates 95% of Fixed code remotes and more than 40 rolling code brands using the latest Cutting Edge mobile technology.
- The M-BT Remote Can integrate up to 4x different remotes to the 1 remote
- Connect your M-BT remote to your mobile phone via Bluetooth and use the JMAREMOTESPRO APP for more advanced functions.
- When integrated with the JMA REMOTES PRO APP it is possible to generate an aftermarket remote for many of the popular Brands that can be introduced to the Receiver



Art ID: M-BT





CUSTOM KEY TAGS

PRODUCT DESCRIPTION

** This is a CUSTOMISED Product - the turn around is 1-2 days once Artwork is approved ** Order Now **

PRODUCT DESCRIPTION

- LOCKTON Customised Key Tag Inserts - Full Colour Design
- Customise your KEY TAGS with your business details
- Quick Easy Design Process - We do the design for you !



PRODUCT SPECIFICATION

- Printed on Perforated A4 Paper
- 4 x A4 Sheets (65 Per Sheet = 260 Inserts)
- Insert Size: 38 x 21 mm

Art ID: **CUST-260**

FREE LASER ENGRAVING

PRODUCT DESCRIPTION

FREE Laser Engraving on LOCKTON Cylinders & Padlocks

- Small MOQ - No Large order quantities!
- Can be purchase in boxes of 10.
- Order x5 + boxes and receive a further discount.
- No Setup Fees
- Quick” turnaround after design approval

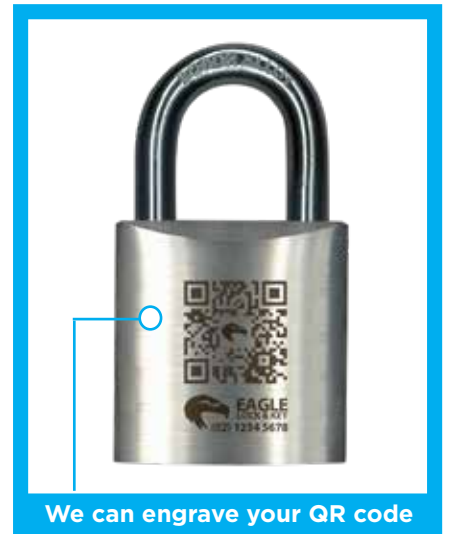

We can engrave your QR code

Talk to your sales rep to get started !



‘Customised’ KEY STICKERS - Pkt of 200

PRODUCT DESCRIPTION

These customised stickers are designed to suit the range of JMA transponder keys, KEYDIY Remotes & XHORSE Remotes. Simply remove the existing sticker and replace with your own design for a full colour “coined” automotive transponder key. This is a great way to advertise your business!

PRODUCT SPECIFICATION

- Weather Proof Vinyl Stickers (Bumper Bar Quality)
- Full Colour
- Design done by SGLOCKS
- Size (Diameter):14mm
- Packet of 200

Art. **TP-COIN**

1-2	\$115.00 Ex GST - PACKET OF 200
3-4	\$103.50 Ex GST - PACKET OF 200
5+	\$92.00 Ex GST - PACKET OF 200



DOMESTYLE

‘Customised’
DOMESTYLE
KEY STICKERS





Art ID: LP-HAVAL

NEW

Art ID: LP-HAVAL

Auto. Pick - GWM / HAVAL - Suits OP-11 (HU100) - IGN/DR - (IC Card 1999)

PRODUCT SPECIFICATION

Lock Profile: Suits OP-11 (HU100)
Tool Type: 2-in-1 Twin Lifter
Compatibility: IGNITION, DOOR & BOOT
Finish: Anti-Glare

Check

sglocks.com.au

For Pricing!

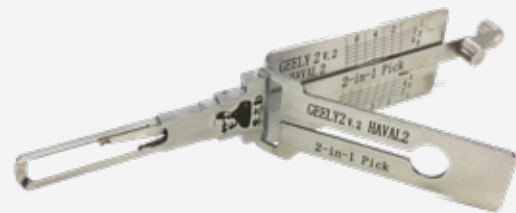

NEW

Art ID: LP-DEC-TOY38R

TOYOTA/DAIHATSU/HINO - Suits Keyways TOYO-20D (TOY38R & DH4R) - Ignition Only

PRODUCT SPECIFICATION

Lock Profile: TOY38R/ DH4R
Tool Type: Decoder Only
Compatibility: Ignition
Finish: Anti-Glare

Check

sglocks.com.au

For Pricing!

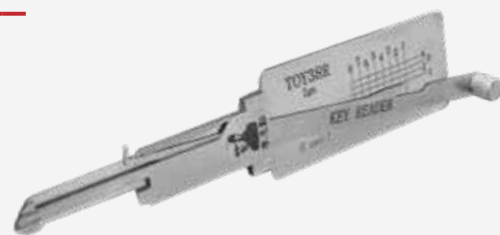

Art ID: LP-HY30



NEW

Art ID: LP-HY30

Auto. Pick - HYUNDAI/KIA - Suits 2022+ HY-19 (HYN17R) - 2 Track - TWIN LIFTER - DR Only

PRODUCT SPECIFICATION

Lock Profile: Suits 2022+ Hyundai
Tool Type: 2-in-1 Twin Lifter
Compatibility: DOOR
Finish: Anti-Glare

Check
sglocks.com.au
For Pricing!

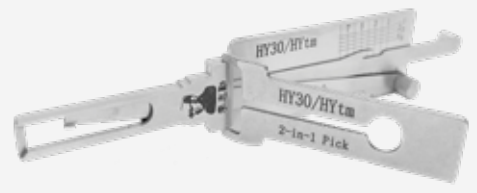

**Exclusive ORIGINAL LISHI
Distributor for Australia &
New Zealand**

150+ LISHI Picks
Stocked for
Immediate Dispatch



Check

sglocks.com.au

For Pricing!

DOOR HARDWARE & FURNITURE



STRIKE SHIELD (BLOCKER PLATE) to suit Cylindrical Locks *Visible Fix* Stainless Steel

PRODUCT DESCRIPTION

The LOCKTON range of Blocker Plates are well suited to add greater security to most door configurations.

PRODUCT SPECIFICATION:

- Application: Suits Cylindrical Locks (cut-out for rose)
- Size (H X W X D): 275mm x 75mm x 2 mm
- Material: Stainless Steel
- Mounting: Visible Fix
- Comes with required bolts

Art. **SS01-SS**



STRIKE SHIELD (BLOCKER PLATE) to suit Cylindrical Locks *Concealed Fix* Stainless Steel

PRODUCT DESCRIPTION

The LOCKTON range of Blocker Plates are well suited to add greater security to most door configurations.

PRODUCT SPECIFICATION:

- Application: Suits Cylindrical Locks (cut-out for rose)
- Size (H X W X D): 275mm x 75mm x 2 mm
- Material: Stainless Steel
- Mounting: Concealed Fix
- Comes with required bolts

Art. **SS02-SS**



STRIKE SHIELD (BLOCKER PLATE) to suit 127mm Backset Cyl. Locks *Concealed Fix* Stainless Steel

PRODUCT DESCRIPTION

The LOCKTON range of Blocker Plates are well suited to add greater security to most door configurations.

PRODUCT SPECIFICATION:

- Application: Suits Cylindrical Locks with 127mm Backset
- Size (H X W X D): 275mm x 75mm x 2 mm
- Material: Stainless Steel
- Mounting: Concealed Fix
- Comes with required bolts

Art. **SS03-SS**



STRIKE SHIELD (BLOCKER PLATE) to suit Narrow Stile Mortice Furniture *Visible Fix* Stainless Steel

PRODUCT DESCRIPTION

The LOCKTON range of Blocker Plates are well suited to add greater security to most door configurations.

PRODUCT SPECIFICATION:

- Application: Suits Narrow Stile Mortice Furniture
- Size (H X W X D): 275mm x 75mm x 2 mm
- Material: Stainless Steel
- Mounting: Visible Fix
- Comes with required bolts

Art. **SS04-SS**



PACKING PLATE to Suit LOCKTON Strike Shields (Blocker Plates) Stainless Steel

PRODUCT DESCRIPTION

The LOCKTON range of Blocker Plates are well suited to add greater security to most door configurations.

PRODUCT SPECIFICATION:

- Application: Packs out Strike Shields by extra 2mm
- Size (H X D): 275mm x 2 mm
- Material: Stainless Steel

Art. **SS50-SS**



LOCKTON

SS/Steel PULL & PUSH PLATE SET (300mm x 100mm)

PRODUCT DESCRIPTION:

LOCKTON PPP-SET-SS - Contains one of each Stainless Steel "Push" Plate & "Pull" Plate. Fixing holes on each plate allows handles to be mounted either back to back or at different heights if needed. Supplied in a box with fixing screws. Often also used to cover existing holes & or damage to doors.

PRODUCT SPECIFICATION :

- Material: Stainless Steel
- Dimensions: 300 mm x 100 mm x 1.5 mm each
- 19mm Diameter Pull Handle
- Fixing Screws provided
- Pack Quantity: 2 x Plates (1 x Push, 1 x Pull)

Art. **PPP-SET-SS**



LOCKTON

S/Steel PULL PLATE with Handle (300mm x 100mm)

PRODUCT DESCRIPTION:

LOCKTON PPP-PULL-SS - Stainless Steel "Pull" Plate.

PRODUCT SPECIFICATION :

- Material: Stainless Steel
- Dimensions: 300 mm x 100 mm x 1.5 mm
- 19mm Diameter Pull Handle
- Often also used to cover existing holes & or damage to doors.
- Pack Quantity: 1 x Plate

Art. **PPP-PULL-SS**



LOCKTON

S/Steel PUSH PLATE (300mm x 100mm)

PRODUCT DESCRIPTION:

LOCKTON PPP-PUSH-SS - Stainless Steel "Push" Plate

PRODUCT SPECIFICATION :

- Material: Stainless Steel
- Dimensions: 300 mm x 100 mm x 1.5 mm
- Often also used to cover existing holes & or damage to doors
- Pack Quantity: 1 x Plate

Art. **PPP-PUSH-SS**



LOCKTON - SCAR PLATE

(RECTANGLE 225x69mm) - CUT-OUT: Round 54mm Dia.

PRODUCT DESCRIPTION:

This LOCKTON Scar Plate is designed to patch and cover-up drill holes and installation points on a variety of domestic entry locksets (see compatibility below).

This plate is also designed to retrofit the LOCKTON Art. ELEV64 to provide a neat and well presented installation.

PRODUCT SPECIFICATION :

- Dimensions (L X W X T): 225 x 69 x 1.2mm
- Hole Cut-out Diameter: 54mm
- Pack Quantity: 1 x Plate
- Compatibility: Gainsborough Trilock, Lockwood Nexion and Lane Corvan

Art. **PS-REC-TNC-SS**

Art. **PS-REC-TNC-SS-BLK**



Check out our full range of Scar Plates available in Aluminium & Stainless Steel



sglocks.com.au



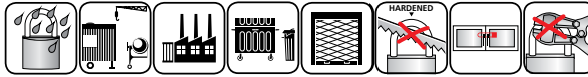

PRODUCT DESCRIPTION:

- Stainless Steel Body
- Chrome-plated Shackle
- Hardened Shackle
- Protection Against Nipping
- 4 Digit Rolls
- 10,000 Different Combinations
- Rubber Impact Protection

PRODUCT SPECIFICATIONS:

- Shackle Clearance = 14mm (Height) x 24mm (Width)
- Total Length = 70mm
- Shackle Diameter = 9mm
- Rustproof locking mechanism

Art.
23-70

Check
sglocks.com.au
For Pricing!



PRODUCT DESCRIPTION

- Solid Brass Body
- Stainless Steel Shackle
- Double bolted
- Ideal for strong weather influences
- Re-settable Combination
- 4 Digit Rolls

PRODUCT SPECIFICATION

- Shackle Clearance = 30mm (Height) x 25mm (Width)
- Body Width = 50mm
- Total Length = 80.5mm

Art.
99-Ni-50

Check
sglocks.com.au
For Pricing!



PRODUCT DESCRIPTION

The spiral cable lock as solid theft protection for your bike. A particularly practical feature of this model is the matching holder for your bike, which is included in the delivery and allows you to store the lock safely and in a space-saving way. Two keys are also included. The length of this spiral cable lock is 150 cm and the diameter of the steel cable is 8 mm.

PRODUCT SPECIFICATION

- Length = 150cm
- Cable Diameter = 8mm

Art.
1260-150

Check
sglocks.com.au
For Pricing!



PRODUCT DESCRIPTION

For solid theft protection for your bike or other items, we have a practical, inexpensive candidate: The 440 bicycle lock - the combination rope lock is especially for children. Available in different colours, there is guaranteed to be a model for every taste. You don't need a key to open and lock the 440 lock. You can open it quickly and conveniently with a three-digit code. The diameter of the steel cable measures 12 mm and the total length is 60 cm

PRODUCT SPECIFICATION

- Length: 60cm
- Shackle Diameter: 5mm

Art.
440-60

Check
sglocks.com.au
For Pricing!



ELECTRIC STRIKE - 12v - 24v

PRODUCT SPECIFICATION

- 12-28V AC/DC
- Monitored Strike- Lock & Door status
- Accepts 15mm latch throw
- Keeper width 39mm
- Selectable from fail safe - Fail secure
- Jaw strength 680kg static strength
- Tested to 1,000,000 cycles

Art. ID: **SGESGK700**



Electric Strike FIXING TAB KIT - Adjustable Offset

PRODUCT DESCRIPTION

Adjustable Offset Fixing Tab Kit for Electric Strikes. This kit is designed to allow the fixing screw to be offset in the frame.

The versatility of this kit means no modifications (cutting and tapping holes) are needed for fixing tabs to fit into most types of aluminium frames. There is also no requirement to remove any internal door frame strengthening as the fixing tabs fit between strengthening profiles.

Supplied as off-set fix for a wider range of fitting options.

Supplied with 1.5mm thick spacer to provide flush installation into 1.5mm thick door frames.

Use without spacer for installation into 3mm door frames, gate posts and inactive door leaf's.

Adjust vertically by sliding 'T' nut for best possible installation results (adjustable type).

PRODUCT SPECIFICATION

Material: Zinc coated Mild Steel
Supplied with:

- 4 x 3/16 counter sunk stainless steel screws
- 2 x 3/16 aluminium 'T' Nuts (T Nuts supplied with adjustable type)
- 1 x 1.5mm Spacer

Art. ID: **ES-FTK-AO**

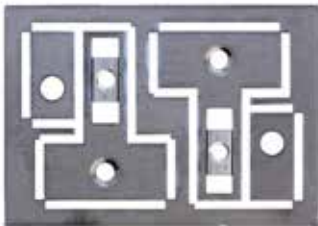

Electric Strike FIXING TAB KIT - Adjustable Centre

PRODUCT DESCRIPTION

Adjustable Centre Fixing Tab Kit for Electric Strikes. This kit is designed to allow the fixing screw to be centred in the frame.

The versatility of this kit means no modifications (cutting and tapping holes) are needed for fixing tabs to fit into most types of aluminium frames. There is also no requirement to remove any internal door frame strengthening as the fixing tabs fit between strengthening profiles.

Supplied with 1.5mm thick spacer to provide flush installation into 1.5mm thick door frames.

Use without spacer for installation into 3mm door frames, gate posts and inactive door leaf's.

Adjust vertically by sliding 'T' nut for best possible installation results (adjustable type).

PRODUCT SPECIFICATION

Material: Zinc coated Mild Steel
Supplied with:

- 4 x 3/16 counter sunk stainless steel screws
- 2 x 3/16 aluminium 'T' Nuts (T Nuts supplied with adjustable type)
- 1 x 1.5mm Spacer

Art. ID: **ES-FTK-AC**

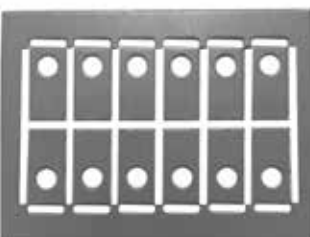

Electric Strike FIXING TAB SPACERS - Set of 12

PRODUCT DESCRIPTION

Packet of 12 Fixing Tab Spacers for Electric Strike Fixing Tab Kits.

PRODUCT SPECIFICATION

Spacer Thickness: 1.5mm
No. of Tabs per Pack: 12
Suits: Centred and Offset Fixing Kits

Art. ID: **ES-FTKS-AO-AC**



WORKSHOP TOOLS

WITTE
WERKZEUGE

'MAXX' ASSORTED
SCREWDRIVER SET (5-Pce)

- Hand-picked materials
- Ergonomic design
- Workmanship and physics all combine here to make a perfect Screwdriver set.



Art ID. 653865



BOKER

Magnetic PICK UP TOOL - 500 gram cap.

- Ideal for retrieving dropped nuts, bolts etc. from inaccessible areas.
- Chrome plated flexible shaft with strong magnet.
- 500 Gram Capacity



Art ID. 3200-0500



WITTE
WERKZEUGE

Maxxpro® - PICKS & HOOKS - SET

- Picks & hooks
- 4 Piece assorted set



Art ID. 691008



BOKER

Clipper Cut BOLT CUTTERS - 460mm

- O/A Length: 460mm
- Soft Metal Cutting capacity [785N/mm² (HRC 20)]: Up to 10mm
- Medium-Hard Cutting capacity [1225N/mm² (HRC 38)]: Up to 7mm
- Jaws made from special tool steel



Art ID. 1387-460



WITTE
WERKZEUGE

Offset SCREWDRIVER SET - Long Arm
(9-Pce Ball HEX - 1.5mm to 10mm)

- High quality and safe: durable, sturdy plastic construction
- Compact: plenty of tools - low space requirement
- Sizes: T9, T10, T15, T20, T25, T27, T30, T40
- High-grade chrome vanadium steel
- Bevelled ends



Art ID. 45032



BOKER

'Orbis' External CIRCLIP PLIERS (Bent) - 130mm
(3 - 10mm)

- Tip Size: A01 'Micro' (0.9mm)
- Length: 130mm
- Bent: 90°
- Circlip Capacity (bore): 3 - 10mm
- EXPANDING - For Outside Rings
- Precision Points (Ground & Hardened)
- Gun Metal Finish
- Chrome Vanadium Steel



Art ID. 1008-B-A01



• DRILLING



• PLIERS



• CHISELS



• PUNCHES &
HAMMERED
TOOLS



• CUTTERS



• SPANNERS &
WRENCHES

Check

sglocks.com.au

For Pricing!

HIGH QUALITY TOOLS WORKSHOP TOOLS

metabo

Angle Grinder CUTTING DISCS - Pkt of 10

- Quality class: A 60 R
- Diameter x thickness x bore: 125 x 1 x 22.23 mm
- Version: straight
- Maximum speed: 13200 rpm



Art ID. AG-C-125

metabo

Angle Grinder GRINDING DISCS - Pkt of 5

- Quality class: A 24
- Diameter x thickness x bore: 125 x 6 x 22.23 mm
- Version: offset
- Maximum speed: 12200 rpm



Art ID. AG-G-125

metabo

Angle Grinder FLAPPER DISCS - 60 Grit

- Diameter x Bore: 125 x 22.23mm / 5 x 7/8"
- Grit: P 60
- Version: Offset
- Maximum Speed: 12200 rpm



Art ID. AG-F-125-60

Fischer

Plastic Products Pty Ltd.

'Fischer' TOOL BOX - Lift Out Tray

- Includes 2 medium storage boxes (6 & 14 compartments)
- Size: (WDH) 465 x 300 x 254mm
- With Lift Out Tray
- Deep bottom storage area
- 4 compartment tote tray including "easy scoop" compartments for small parts
- Sturdy co-polymer construction
- Bold, rugged design
- Large nickel-plated drawbolts
- Recessed luggage type carrying handle
- Partitioned tote tray
- Tongue and groove lid
- Handle & Clips - A.B.S.
- Ideal for Tradesman or Handyman
- Design and made in Australia



Art ID. TB-1H126

Fischer

Plastic Products Pty Ltd.

'Fischer' TOOL BOX - No Inserts

- Size: (WDH) 465 x 300 x 254mm
- Deep bottom storage area
- Sturdy co-polymer construction
- Bold, rugged design
- Large nickel-plated drawbolts
- Recessed luggage type carrying handle
- Partitioned tote tray
- Tongue and groove lid
- Handle & Clips - A.B.S.
- Ideal for Tradesman or Handyman
- Design and made in Australia



Art ID. TB-1H123



+ MUCH

MUCH MORE

MADE IN GERMANY

- TAPS, DIES
- MEASURING & MARKING
- EXTRACTORS
- SAWS & FILES



“The Griffs got you covered” Promo



AVAILABLE SIZES :

ADULTS S, M, L, XL, XXL

Specify preferred size in ORDER NOTES

LOCKTON Camo Shirt

SPEND OVER \$790.00*
ON

sglocks.com.au

In the one order AND RECEIVE YOUR LOCKTON ‘Camo’ SHIRT

OR

SPEND OVER \$1390.00*
ON

sglocks.com.au

In the one order AND RECEIVE LOCKTON ‘Camo’ SHIRT & HAT

LOCKTON Camo Shirt & Hat



The Griffin is a mythological creature that is half lion & half eagle. Eagles are generally considered the king of birds, and Lions the king of beasts.

The Griffin is symbolic of both power and bravery and is often portrayed as guarding treasure or wealth.

LOCKTON and its Griffin
“Your Protector & Guardian”

* FEB 23 Promo ” valid until 28th February 2023 or whilst stocks last.* Free Promotion item is only valid for online orders * Pricing shown excludes GST pricing as of 01/02/2023 and is subject to change. For most accurate pricing please check the SGLOCKS website.



Head Office
PH : 02 9352 0600
FAX: 02 9748 0566

Your Sales Managers:

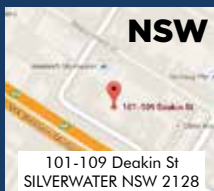

Colin McFarland
0491 445 005

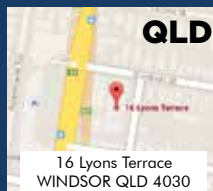

Vince Carson
0437 770 576

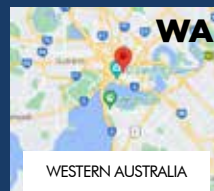

Cole Cullen
08 6383 7533

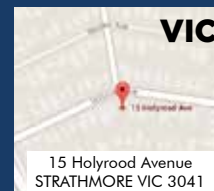

Henry Guldon
0400 613 714

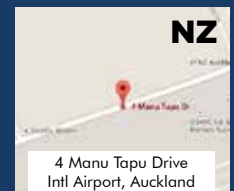

NZ Toll Free
0800 00 15 98