

SGLOCKS

Newsletter

OCT/NOV 2022
ISSUE 97



CELEBRATING
40 YEARS
OF THE MAAA

MAAA EXPO BUMPER EDITION



SG Lock & Security is a wholesale distribution company with over 70 years experience. Innovation is what drives us. We distribute throughout Australia and New Zealand an expansive range of traditional and modern security products sourced both internationally and locally.

Our company is defined by our 3 Core Values:

Customer Service & Satisfaction

Our customers are our partners and our goal is to provide the best possible service and customer satisfaction

Quality & Value

We supply products that are high quality while at the same time offering great value.

Innovation

We are small enough to listen to our customers and large enough to deliver better solutions for their businesses.



AccessTools

Pages 4-5

ML20
Restricted Key System

Pages 42-45

AUTEL

Pages 6-11

 **ORIGINAL
LISHI TOOLS**

Pages 46-49



Pages 12-17

 **SGT**

Pages 50-51



Pages 18-19

 **Lock Pins**

Pages 52-55

JMA

Pages 20-25



Pages 56-57

 **KEYDIY**

Pages 26-27

 **Xhorse**

Pages 58-59

Lockdecoders

Pages 28-29

XTOOL
AUSTRALIA

Pages 60-63



Pages 30-41



Since 1986, ACCESS TOOLS has been producing World Class automotive opening tools and they are a leading manufacturer of automotive lock-out equipment for locksmiths and emergency services all around the world. The ACCESS TOOLS range is comprehensive enough that it covers a vast majority of the most important lock-out tools for the car opening professional. With their standout quality products being produced in house at their head office in the USA, ACCESS TOOLS is the "Leader in Automotive Specialty Tools".



LONG REACH SETS

EMERGENCY RESPONSE KIT

Designed by first responders, the Emergency Response Kit has all the tools that you need to get into any vehicle on the road in an emergency situation. This kit is small enough to fit in almost any vehicle.

- Designed for first response
- Emergency ready
- Most popular accessories
- Gets into most vehicles



ONE HAND JACK SET

The One Hand Jack Set is one of Access Tools' - most popular selling products. It is designed to include the essentials needed to get into most vehicles quickly and effectively.

- Top selling kit
- Designed for all vehicles
- Store-N-Go handle
- Scratch resistant coating



SUPER PRO COMPLETE KIT

The Super Pro Complete Set is the most complete lockout set from Access Tools. Using the included Car Opening Manual, all basic car opening procedures are outlined in detail to make lockouts quick and easy.

- Instruction Manual
- Our most complete set
- Tool ID system
- High quality in-the-door tools
- Best selling accessories included



Check

sglocks.com.au

For Pricing!



LONG REACH TOOLS

FLEXIBLE LONG REACH TOOL

- Can be bent, twisted, & shaped
- Approx 55" when straightened
- Great for hard to reach places

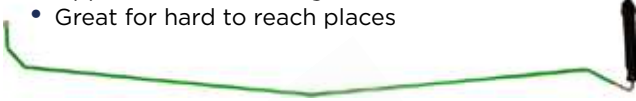

REMOTE CONTROL BUTTON MASTER

- Flexible coated long reach tool
- Retractable loop with grip cover
- Grabs vertical door buttons

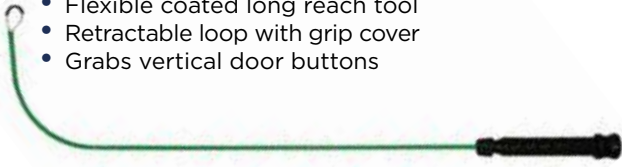

REMOTE CONTROL MEGA MASTER



- Flexible coated long reach tool
- XL retractable loop with grip cover
- Grabs door handles, keys & knobs



SHIELDED QUICK MAX

- Can be bent, twisted, & shaped
- Approx 52" when straightened
- Store-N-Go handle - extra tips

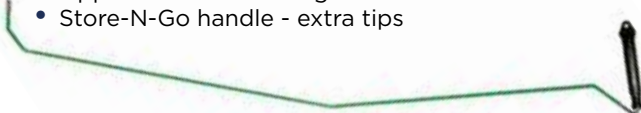

WEDGES

AIR JACK

- Made of ballistic nylon
- Inflates easily & quickly
- Extremely durable



SUPER AIR JACK

- Made of ballistic nylon
- Large air wedge



TWIN AIR JACK

- Made of ballistic nylon
- Double air wedge



GLASSMAN TOOL

- Designed for frameless window vehicles
- Lexan sheets



ONE HAND JACK

- For small vehicles
- Pry tool separates door from frame



SUPER ONE HAND JACK

- For larger vehicles
- Pry tool separates door from frame



WEDGEE CURVED WEDGE

- Quick & easy insertion
- Bypass window sash



ACCESSORIES

ACCESS SMART LIGHT

- 500 Lumen COB LED
- Heavy Duty Suction Cups



AIR JACK REPAIR KIT

- Repairs any Air Jack
- One size fits all



DAMAGE GUARD

- Protective tape material
- 2" Wide x 100" Long

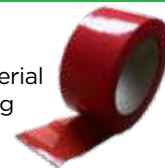



Autel specialises in the Research and Development, production, sales and service of automotive intelligent diagnostics, detection, and programming systems. Autel products are sold to more than 50 countries and is one of the world's leading providers of automotive intelligent diagnostics.

Established in 2004, Autel is now recognized by the automotive aftermarket industry as one of the fastest growing scan tool companies with their headquarters based in China and flagship offices in North America, Germany, Mexico, UAE, and Japan.

They are driven to provide the most extensive and best price-performance ratio OEM level diagnostic products and first-class customer support in the world with their IM608-PRO leading the charge.

IM608PRO *BEST FOR - INTERMEDIATE LEVEL AUTO LOCKSMITHS*

IM608 TABLET

- Rechargeable Li-ion Battery 15000 mAh
- Internet Updatable via Wi-Fi
- Multilingual Support
- Limited Two Year Warranty
- Touchscreen 10.1-inch
- Memory 64GB
- Processor Hexa-core
- Camera 8.0 Megapixel
- Resolution 1920x1200
- Bluetooth connection to MAXIFLASH (below)



MAXIFLASH JVC1

- Connects the device to the vehicles OBD Port via a standard high density DB-26 MVCI-OBDDII Cable.
- Fully compatible with both SAE J2534-1 and J2534-2 reprogramming standards
- Fast performance ensures quickly reprogramming even the newest controllers
- Wireless with advanced networking functions
- Built-in wireless and data storage
- Rugged design capable of withstanding harsh environments
- Internet updateable



XP400 PRO: DATA READ & CHIP PROGRAMMING FUNCTIONS

Read/Write Data

- Support 400+ EEPROM chip types
- Support 2000+ MCU chip types
- Support 40+ engine ECU chip types
- Support 200+ immobilizer ECU chip types

Key Unlock

- Support 11 key types (Volkswagen/Audi/BMW/Benz)

Chip writing/ Pre-program

Key Chip Read/Write, Key Frequency Detection, Key Generation, Infrared Key Read/Write

IM608PRO-KIT

BEST FOR -
ADVANCED LEVEL
AUTO LOCKSMITHS

AUTEL®

AUTEL® IM608PRO

ADVANCED KEY PROGRAMMING TOOL



SCAN HERE
FOR MORE
DETAILS



SRS⁺
BY SGLOCKS
AUTEL®

Check

sglocks.com.au

For Pricing!

INDIVIDUAL COMPONENTS

Art.	Description	Price ex.GST
IM608-PRO	ADVANCED KEY PROGRAMMING TOOL - Inc. 12 mths Software Updates (includes IM608 Tablet -MaxiFlash- XP400 Pro & Carry case)	CFP
IMKPA	EXPANDED KEY PROGRAMMING - 10x Accessories & Carry case	CFP
G-BOX2	FAST-MODE IMMO DECODER- For BENZ,BMW,EURO etc.	CFP
APB112	SMART KEY SIMULATOR - For TOY/LEX (46, 4D & H)	CFP
A-NIS-16-32	ADAPTOR CABLE - NISSAN 16 + 32 (SGM Systems)	CFP
A-CHR-12-8	ADAPTOR CABLE - CHRYSLER 12 + 8 (SGM systems)	CFP

AUTEL® IM608PRO

This dedicated Immo Module has been designed with the Locksmith in mind.

The IM608 Immobiliser module is a reflection of 17 years of OEM-Level Diagnostic experience. The **IMMO status scan** screen integrates all the useful information into one screen laying out every function in easy to follow guides **step-by-step**. Selecting this screen automatically displays the parts of the immobiliser system that are relevant. It then runs a fault code scan on these modules prior to programming. All relevant info like Vin, Key Count, Number of Available Key Positions etc. will also be displayed here.

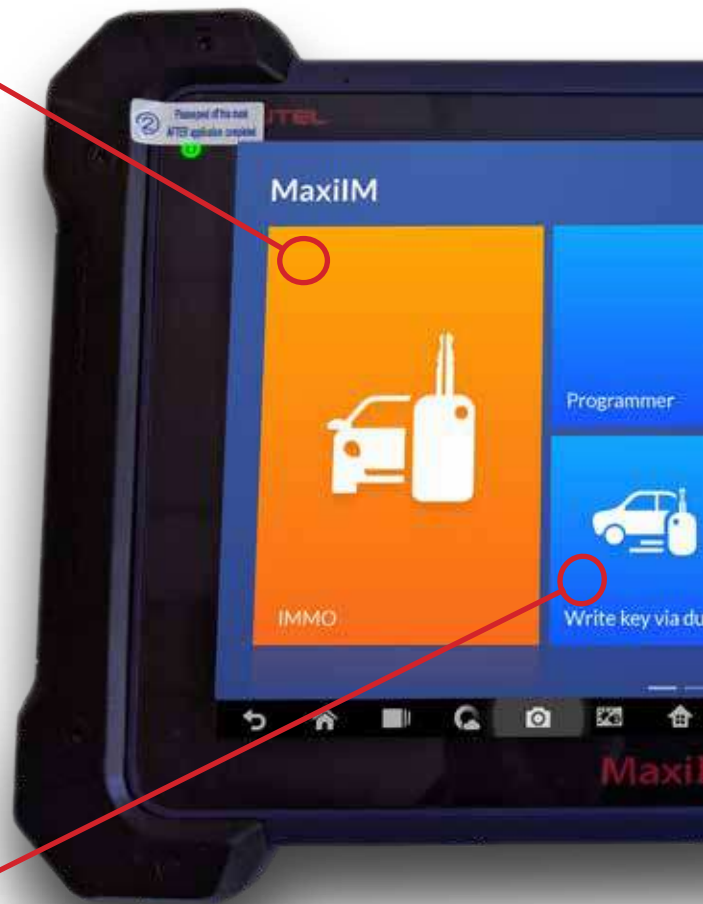

Scan Item	Status
Fault code(DTC)	Reading DTCs...
Fault code(PCM)	Not scanned
Number of programmed smart keys	Not scanned
The specified minimum number of keys	Not scanned

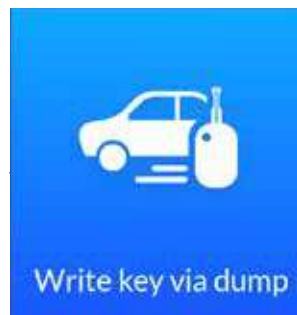

A complete module dedicated to creating immobiliser keys via reading the eeprom or equivalent on the bench.

Replaces the need to buy a secondary eeprom calculation tool.

Over **1400+** different eeprom modules .

This module is unique in that it does not require a secondary Hardware & software to Read & write the data.

The EEPROM can be Read and Key position can be chosen. Then the transponder can be written to the eeprom in one step - by selecting **One-touch Processing**. Alternatively an eeprom file can also be imported if it was read from another tool.

Key Information	Key Position
Vehicle type: Toyota, Corolla, 2004-2006, Immobiliser	Key 1
Original transponders chip: TIRG 4C	Key 2
Allowed transponders chip: TIRG 4C	Key 3
Data location: ESPROM 900M	Key 4
Data size: 512 Bytes	Key 5



A complete module dedicated to Reading and writing Transponders, EEPROM, Flash & MCU Processors.

Replaces the need to buy several dedicated Programming Machines.

200+ Diagram's & images for vehicle specific In-Circuit programming, removing the need to remove processors from the PCB.

2000+ Eeprom Flash MCU types supported
96- Ecu Read & write function

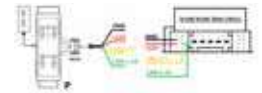

Key Chip Read/Write, Key Frequency Detection, Key

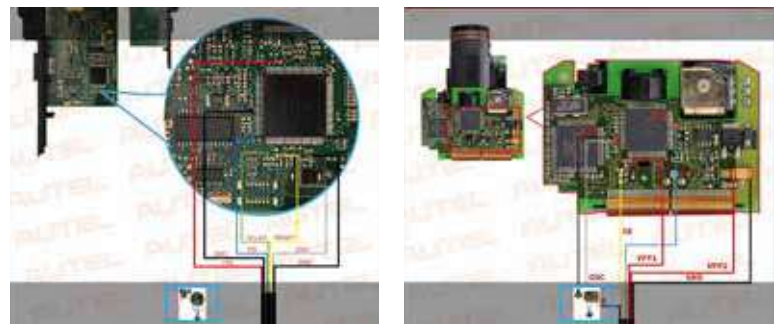

NEW



A New module dedicated to the generation of AUTEL Universal Smart Keys

Replaces the need to order smart keys for late model vehicles. AUTEL can generate smart keys onto it's universal smart key range for **49+** Vehicle manufacturers.

All Models referenced with year models for easy selection.

AUTEL smart Keys are generated wirelessly via the UP400Pro programmer

NEW

NEW

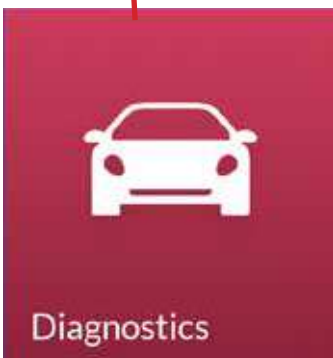

Established in 2004, Autel is now recognized by the automotive aftermarket industry as one of the fastest growing scan tool companies providing the most extensive and best price-performance ratio OEM-level diagnostic products and first-class customer support in the world.

The **IM608** also contains a fully loaded OEM-Level Diagnostic facility that can be utilised by Locksmiths to diagnose Immobiliser & Remote system Faults.

Being a dealer level machine - it is also possible to Relink modules & Recode replacement parts when new modules are installed that impact the immobiliser system.

AUTEL®

NEW



UNIVERSAL **SMART KEY** RANGE



COME SEE
THIS AT



**MASTER
LOCKSMITHS**

ASSOCIATION OF AUSTRALASIA

40 YEAR
1922
2022
EXPO

- **49+** VEHICLE
MANUFACTURERS
- GENERATE THE
LATEST MODELS
- WIRELESS GENERATION
- HIGH QUALITY
SMART KEY RANGE



BATTERY SAFETY COMPLIANT

FULL RANGE COMPLIANCE TESTED
BY INDEPENDENT THIRD-PARTY
NATA ACCREDITED TESTING
LABORATORIES



AUTEL[®]

'RAZOR' SERIES

Art.ID SK- BW3AL



Art.ID SK- BW4AL



'S' SERIES

Art.ID SK-AT2AL



Art.ID SK- AT3AL



Art.ID SK- AT3BL



Art.ID SK-AT4BL



Art.ID SK- AT4CL



Art.ID SK- AT4EL



Art.ID SK- AT5BL



Art.ID SK- AT5CL



Art.ID SK- AT6BL





The name BURG-WÄCHTER has been synonymous with private and commercial security for over a century.

Specialising in locks and bolts, safes, cash boxes, key cabinets and letterboxes, BURG-WÄCHTER develops and produces high quality, user-friendly security products to the highest standards of German engineering, under the slogan "Always the Safe Choice".

BURG WÄCHTER celebrates over 100 years in business & SIEPER Group are proud to have been their business partner for over 2 decades.



FEATURED PRODUCT TRAINING SESSION

Friday 21 October 2022
12:00 pm - 1:00 pm
Beechmont 1

Smart Entry Basics -
Simplified solutions for
Emerging market
demands

NEW

'SecuENTRY Home' ELECTRONIC DOOR LOCK



PRODUCT DESCRIPTION:

Simple, secure, convenient!
Keys can be a thing of the past thanks to the electronic door cylinder. Retrofits most Euro Mortice locks giving your customer a great alternative to update & modernise their existing hardware without replacing the lock or patching/ replacing their door.

PRODUCT SPECIFICATIONS:

- Suitable for use with the free secuENTRY KeyApp without any additional components
- Up to six different users
- Easy installation, no measuring required. Suitable for all door thicknesses up to 118 mm (59/59).
- Modern Bluetooth standard 5.2 LE with secure AES encryption
- Low battery warning
- Incl. batteries (AA), accessories, operating and installation instructions
- Open the secuENTRY Home cylinder with a six-digit security code or phone application.
- One admin code and one user code programmable with secuENTRY KeyApp
- Illuminated keypad with practical push buttons
- Protection class IP 53
- Modern Bluetooth standard 5.2 LE with secure AES encryption
- Range between keypad and cylinder: max. 4 metres

Art.
TSE-5001

Check
sglocks.com.au
For Pricing!



'Combi-Line' SAFE - Electronic

PRODUCT DESCRIPTION:

- The BURG-WÄCHTER Combi-Line range of Safe Cabinets are both Security & Fire Certified. They are ideal for the safe storage of documents, cash, jewellery, arms or ammunition, coins and valuables.
- Security Level S 2 according to DIN EN 14450
- Security Level B according to VDMA 24992, May 1995
- Insurance Rating \$35,000 approx.
- Fire Resistance LFS 30 according to EN 15659 - 30 minutes fire protection for paper
- Fire-protective material according to DIN 4102
- Composite insulation in front of the door leaf as heat protection for the lock and bolts
- Tested and certified protection against burglary and fire
- Double-walled construction
- Internal hinge
- Lateral locking through strong round bolts of 25 mm plus sliding bolt on the top
- All-over gripping rail on the hinge side
- Prepared for both wall and floor fixing, with fixing material - extreme high breaking strength
- Colour: Black
- Standard series with 1 shelf each
- Fixing hole diameter to suit up to 10 mm bolt



INSURABLE RATING
Recommended up to
\$35,000



Security Level B according to VDMA
Certified protection against burglary



FIRE RESISTANCE GRADE LFS 30
Certified protection against fire

SecuTronic - Code lock with EBS Certification

- ECB-S certified safe lock according to EN class A
- Programmable electronic combination lock
- Admin & 1 User code
- Audit Trail shows time and date that User 1 has opened safe
- 1,000,000 different codes possible Version E "SecuTronic"



Art ID. CL410-E

- Exterior Size (H x W x D): 320 x 435 x 380 (not including key pad)
- Keypad protrudes 15mm & handle protrudes 63mm only when pulled out to open safe
- Interior Size (H x W x D): 205 x 320 x 232
- Door Size (H x W): 205 x 265
- Weight (KG): 44
- Volume(L): 15



Art ID. CL420-E

- Exterior Size (H x W x D): 360 x 495 x 445 (not including key pad)
- Keypad protrudes 15mm & handle protrudes 63mm only when pulled out to open safe
- Interior Size (H x W x D): 245 x 380 x 297
- Door Size (H x W): 245 x 325
- Weight (KG): 55
- Volume(L): 27



Art ID. CL440-E

- Exterior Size (H x W x D): 560 x 495 x 445 (not including key pad)
- Keypad protrudes 15mm & handle protrudes 63mm only when pulled out to open safe
- Interior Size (H x W x D): 445 x 380 x 297
- Door Size (H x W): 445 x 325
- Weight (KG): 77
- Volume(L): 50

'Combi-Line' SAFE - Keyed



Art ID. CL410-K

- Exterior Size (H x W x D): 320 x 435 x 380
- Interior Size (H x W x D): 205 x 320 x 232
- Door Size (H x W): 205 x 265
- Weight (KG): 44
- Volume(L): 15
- Key Blank: KB-55



Art ID. CL420-K

- Exterior Size (H x W x D): 360 x 495 x 445
- Interior Size (H x W x D): 245 x 380 x 297
- Door Size (H x W): 245 x 325
- Weight (KG): 55
- Volume(L): 27
- Key Blank: KB-55



Art ID. CL440-K

- Exterior Size (H x W x D): 560 x 495 x 445
- Interior Size (H x W x D): 445 x 380 x 297
- Door Size (H x W): 445 x 325
- Weight (KG): 77
- Volume(L): 50
- Key Blank: KB-55

'Karat' SAFE - Electronic

PRODUCT DESCRIPTION:

- Insurance rating \$70,000
- Protected against burglary and fire.
- Triple-walled body.
- Exterior walls made from flame-cutting resistant stainless steel.
- Double-walled door, with additional armouring.
- Door leaf thickness 7mm Siemens-Martin Steel.
- Three sided locking through strong square bolts.
- Top and bottom bolts feature integrated steel rollers to protect against cutting attacks.
- Extreme protection against flame cutting, drilling and attack
- All over gripping hinge.
- Prepared for both wall and floor fixing - fixing materials extremely high breaking strength.
- Fire protective material in body and door, with special fire-fold for added protection.
- Depth for files of common size, with 1 adjustable shelf.
- Platinum grey finish.
- Armoured high security double-bit lock (Resettable lock)

SecuTronic - the first biometric safe lock with VdS Certification

- Developed by BURG-WÄCHTER.
- VdS approved lock with fingerscan module, EN 1300 class 2.
- Programmable electronic lock.
- 10 x 6-digit pincodes.
- 1,000,000 possible combinations.
- Up to 20 x fingerscans.
- When opening with fingerscan, 2 different fingers must be entered/programmed.
- Scanner only accepts 'real, live fingers.'
- Precise finger scanner, for accurate reading.
- Intelligent, menu driven operation.
- Administration of up to 10 users, 1,000,000 million different combinations and up to 300 optional TSE E-keys.
- User names, access times and rights, calendar functions etc are available.



INSURABLE RATING
Recommended up to
\$70,000



SECURITY GRADE B ECB-S
Certified protection against burglary

Electronic / Fingerscan
(EN 1300 CLASS B LOCK)



- New Pad design
- High quality touch electronics
- 1 administrator and 9 user codes
- Simple intuitive menu structure
- Time - Date - Year
- Audit trail
- Integrated fingerprint module
- 20 fingerprints



Art ID. MT640-E-FP

- Exterior Size (H x W x D): 340 x 430 x 390
- Interior Size (H x W x D): 250 x 348 x 294
- Door Size (H x W): 250 x 336
- Weight (KG): 48kg
- Volume(L): 25.8
- Keypad protrudes 15mm & handle protrudes 63mm only when pulled out to open safe



Art ID. MT660-E-FP

- Exterior Size (H x W x D): 530 x 430 x 390
- Interior Size (H x W x D): 440 x 348 x 294
- Door Size (H x W): 440 x 336
- Weight (KG): 60
- Volume(L): 45.3
- Keypad protrudes 15mm & handle protrudes 63mm only when pulled out to open safe

'Karat' SAFE - Keyed



Art ID. MT640-K

- Exterior Size (H x W x D): 340 x 430 x 390
- Interior Size (H x W x D): 250 x 348 x 294
- Door Size (H x W): 250 x 336
- Weight (KG): 48
- Volume(L): 25.8



Art ID. MT660-K

- Exterior Size (H x W x D): 530 x 430 x 390
- Interior Size (H x W x D): 440 x 348 x 294
- Door Size (H x W): 440 x 336
- Weight (KG): 60
- Volume (L): 45.3



INSURABLE RATING
Recommended up to
\$110,000



SECURITY GRADE B ECB-S/VdS
Certified protection against burglary



FIRE RESISTANCE GRADE LFS 60 P
Certified protection against fire

Electronic / Fingerscan
(EN 1300 CLASS B LOCK)



- New Pad design
- High quality touch electronics
- 1 administrator and 9 user codes
- Simple intuitive menu structure
- Time - Date - Year
- Audit trail
- Integrated fingerprint module
- 20 fingerprints

'Diplomat' SAFE - Electronic/Finger Scan

PRODUCT DESCRIPTION:

- Tested and supervised security by ECB.S/VdS.
- Insurance rating \$110,000
- Certified protection against burglary and fire.
- ECB.S Certified to Resistance Grade 1
- Resistance Grade I according to EN 1143-1
- Certified fire protection according to EN 15659. LFS 60 P
- Certified 60 minute protection against fire.
- Triple-walled body with armoured, special fireproof insulation.
- BURG-WÄCHTER special 'FPC Buildup' insulation in body and door.
- Special rear wall construction with additional armoring.
- Four-walled door with extensive armoring to protect boltwork and lock.
- Door also features BURG-WÄCHTER's patented, non-resettable double emergency locking system.
- Four sided locking through strong round bolts.
- Recessed door for added protection.
- Specially concealed hinges.
- Heat sensitive seals - swells to seal door in event of a fire.
- Prepared for both wall and floor fixing - fixing materials included.
- Accepts up to 12mm bolt
- Depth for files of common size, with 1 adjustable shelf.
- Silver metallic finish.



SecuTronic - the first biometric safe lock with VdS Certification

- Developed by BURG-WÄCHTER.
- VdS approved lock with fingerscan module, EN 1300 class 2.
- Programmable electronic lock.
- 10 x 6-digit pincodes.
- 1,000,000 possible combinations.
- Up to 20 x fingerscans.
- When opening with fingerscan, 2 different fingers must be entered/programmed.
- Scanner only accepts 'real, live fingers.'
- Precise finger scanner, for accurate reading.
- Intelligent, menu driven operation.
- Administration of up to 10 users, 1,000,000 million different combinations and up to 300 optional TSE E-keys.
- User names, access times and rights, calendar functions etc are available.



Art. MTD780-E-FP



Art. MTD760-E-FP



Art. MTD750-E-FP



Art. MTD740-E-FP

- | | | | |
|--|--|--|---|
| <ul style="list-style-type: none"> • Exterior Size (H x W x D): 985 x 500 x 462 (not including key pad) • Keypad protrudes 15mm & handle protrudes 63mm only when pulled out to open safe • Interior Size (H x W x D): 860 x 372 x 300 • Door Size (H x W): 860 x 337 • Weight (KG): 186 • Volume(L): 96.0 | <ul style="list-style-type: none"> • Exterior Size (H x W x D): 625 x 500 x 462 (not including key pad) • Keypad protrudes 15mm & handle protrudes 63mm only when pulled out to open safe • Interior Size (H x W x D): 500 x 372 x 300 • Door Size (H x W): 500 x 337 • Weight (KG): 132 • Volume(L): 55.8 | <ul style="list-style-type: none"> • Exterior Size (H x W x D): 470 x 500 x 462 (not including key pad) • Keypad protrudes 15mm & handle protrudes 63mm only when pulled out to open safe • Interior Size (H x W x D): 345 x 372 x 300 • Door Size (H x W): 345 x 337 • Weight (KG): 104 • Volume(L): 38.5 | <ul style="list-style-type: none"> • Exterior Size (H x W x D): 380 x 500 x 462 (Does not include keypad) • Keypad protrudes 15mm & handle protrudes 63mm only when pulled out to open safe • Interior Size (H x W x D): 255 x 372 x 300 • Door Size (H x W): 255 x 337 • Weight (KG): 92 • Volume(L): 28.3 |
|--|--|--|---|

Magno PADLOCK Range



PRODUCT DESCRIPTION:

- Solid Brass Body
- Double Bolted
- Hardened Chrome Plated Steel Shackle
- Rustproof Interior
- High Breaking Strength

PRODUCT SPECIFICATIONS:

- Available in: KD (Key Differ), KA (Keyed Alike) Carded (KD), Long Shackle, S/S Shackle, Closed Shackle & Adjustable Shackle
- Body Width available: 15mm, 20mm, 25mm, 30mm, 35mm, 40mm, 45mm, 50mm, 60mm
- Spare Key Blanks available

Art.	Size	Available variations
400-E-15	15 mm	KD, KA & Carded (KD)
400-E-20	20 mm	KD, KA, Carded (KD) & Long Shackle
400-E-25	25 mm	KD, KA & Carded (KD)
400-E-30	30 mm	KD, KA & Carded (KD) & S/S Shackle
400-E-35	35 mm	KD, KA & Carded (KD)
400-E-40	40 mm	KD, KA, Carded (KD), Long Shackle, S/S Shackle & Closed Shackle
400-E-45	45 mm	KD, KA & Carded (KD)
400-E-50	50 mm	KD, KA, Carded (KD), Long Shackle, S/S Shackle, Closed Shackle & Adjustable shackle
400-E-60	60 mm	KD, KA & Carded (KD)

SCAN TO SEE
THE FULL RANGE OF
MAGNO PADLOCKS

sglocks.com.au



'Scan & Lock' 53mm PADLOCK



Art.
610-53

PRODUCT DESCRIPTION:

- BURG WÄCHTER Scan & Lock padlock with finger print scan.
- Suitable for indoor and outdoor (IP65) use and up to 10 individual users / finger prints.
- Great for personal lockers, cellar and garden shed doors. Also ideal for use in office and food service environments.

PRODUCT SPECIFICATIONS:

- Hardened steel shackle
- Up to 10 fingerprints can be saved
- Weatherproof, protection class IP 65
- Includes charging cable and 2 emergency keys
- Low Battery warning
- Lock Width : 53cm
- Shackle Diameter : 5mm
- Shackle Width : 12mm
- Shackle Height : 27mm
- Weight : 0.26kg

IDEAL FOR:

- Wine Cellars
- Garden Sheds
- Offices
- Food Service



'Commercial' Combination Padlock Range



Art.
99-Ni-50

PRODUCT DESCRIPTION:

- Solid Brass Body
- Stainless Steel Shackle
- Double bolted
- Ideal for strong weather influences
- Re-settable Combination
- 4 Digit Rolls

PRODUCT SPECIFICATIONS (99-Ni-50):

- Carded
- Body Width: 50mm
- Total Length: 80.5mm
- Shackle Clearance: 30mm (Height) x 25mm (Width)
- Shackle Diameter: 8mm

PRODUCT SPECIFICATIONS (99-Ni-HB-50/65):

- Carded
- Body Width: 50mm
- Total Length: 107.5mm
- Shackle Clearance: 57mm (Height) x 25mm (Width)
- Shackle Diameter: 8mm



Art. 99-Ni-HB-50/65

'Chromo' Combination Padlock Range



PRODUCT DESCRIPTION:

- Aluminium Body
- Shackle Chrome Plated
- 3 Digit Rolls (90-20, 90-30)
- 4 Digit Rolls (90-40)

PRODUCT SPECIFICATIONS:

- Carded
- Body Width available: 20mm, 30mm & 40mm

Art.	Size	Length	Shackle Clearance	Shackle size	Price ex. GST
90-20	20mm	55mm	22mm x 9mm	3.2mm	CFP
90-30	30mm	75mm	27mm x 12mm	5mm	CFP
90-40	40mm	90mm	32.5mm x 18.5mm	6.5mm	CFP

'Combi-Lock' Combination Padlock Range



PRODUCT DESCRIPTION:

- Solid Brass Body
- 3 Digit Rolls (80-15, 80-20, 80-30)
- 4 Digit Rolls (80-40)

PRODUCT SPECIFICATIONS:

- Carded
- Body Width available: 20mm, 30mm & 40mm

Art.	Size	Length	Shackle Clearance	Shackle size	Price ex. GST
80-15	15mm	44mm	16mm x 6.5mm	3mm	CFP
80-20	20mm	55mm	22mm x 9mm	3.2mm	CFP
80-30	30mm	75mm	27mm x 12mm	5mm	CFP
80-40	40mm	90mm	32.5mm x 18.5mm	6.5mm	CFP



Since 2012, SG Lock & Security have been a specialist supplier of replacement OEM and Aftermarket GARAGE & GATE remotes that cover a vast majority of the most popular Australian & New Zealand garage and gate motors.

With in-depth remote compatibility & programming instructions the SGLOCKS Remote Identification book has become the market leading resource for finding and programming replacement GARAGE & GATE remotes.

In addition to this Remote Identification Booklet each GARAGE & GATE remote supplied by SGLOCKS is packed with clear and concise Remote Programming instructions & Other important information about the remote.

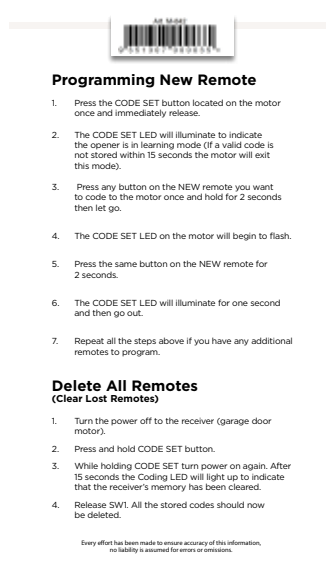

ALL REMOTES INCLUDE

All Remotes come individually packaged with the following information:

- Remote Compatibility Shows range of remotes it can replace
- Programming Instructions Done by customer in front of Garage/Gate
- Barcode Included All remotes are barcoded

SCAN TO SEE THE FULL GARAGE & GATE RANGE ON



BSC - DECLARATION OF COMPLIANCE CERTIFICATES ON FULL RANGE



ALL REMOTES COME WITH A FREE MAXELL BATTERY



BATTERY SAFETY COMPLIANT

ALL REMOTES COME WITH END-USER PACKAGING THAT INCLUDES PROGRAMMING INSTRUCTIONS TO PROVIDE TO YOUR CUSTOMER ON COMPLETION OF SALE.

TOP 10 OEM

ATA 'PTX4' 4 Channel REMOTE



Art. PTX4

PRODUCT DESCRIPTION
ATA PTX4 remote
Controls up to four garage doors or gates
Compatible with PTX4-P, MC100AML, PTX4v1, TX2, HC101, HC107, HC106, HC105, HC108, HC104, HC102

PRODUCT SPECIFICATION:

- Suits models: All ATA 433.92Mhz motors, ATA GDO-2v5, v6, v7, ATAGDO-4v3, v4, v5, v6, ATA GDO-6 v1, v2, ATA GDO-7 v1, SecuraLift 2, ATA GDO-8 v1, v2, ATA GDO-9 v1

ATA 'PTX6' 4 Channel REMOTE



Art. PTX6

PRODUCT DESCRIPTION
ATA PTX6 remote
Controls up to four garage doors or gates
Compatible with PTX2v2, PTX5-P, MC100AML, PTX6, PTX5, PTX2, WTX4-V2, PTX5-D

PRODUCT SPECIFICATION:

- Number of Buttons: 4
- Colour: Grey
- Suits models: ATA GDO-6 v3, ATA GDO-7 v2, ATA GDO-8 v1, v2, ATA GDO-9 v2, ATA GDO-9 v3, GDO-10, GDO-11, SGO-1 DCB-05, NES24v1, GDO-7v2, GD09v2, GDO9v3 & GDO11

MERLIN PREMIUM - 4-Channel



Art. E960M

PRODUCT DESCRIPTION
MERLIN premium remote
Controls up to four different doors or gates
Multi-frequency 433.92Mhz / 433.92Mhz / 434.54Mhz
Battery & Key ring included

PRODUCT SPECIFICATION:
Suits models: Merlin MR600, MR800, MR650, MR850, MT5580P, MT60, MT60P, MT600, MT800, MT1000, MJ3800, MR1000, MT230, ML700, ML750, ML850, HC100AML, HC400ML, HC500ML, HC600ML, MR650EVO, MR850EVO & MT3850EVOHC400ML, HC500ML, HC600ML, MR650EVO, MR850EVO & MT3850EVO1

MERLIN MINI - 2-Channel *NEW VERS.*



Art. M-842RS

PRODUCT DESCRIPTION

Merlin round mini remote
Controls up to two garage doors or gates
Compatible with M842, M-844, MC100AML, M834, M128, includes Battery, key ring & Visor clip

PRODUCT SPECIFICATION:

- Number of Buttons: 2
- Colour: Black & green
- Suits models: Merlin M-530, M-532 receivers
- Frequency: 433Mhz

MERLIN FOB REMOTE - Water Resistant - 4-Channel



Art. E980M

PRODUCT DESCRIPTION
Capable of coding both Merlin+ and Merlin+ 2.0 Motors

PRODUCT SPECIFICATION:
Suits models: Commander Essential (MS65MYQ), Commander Elite (MS105MYQ), Commander Extreme (MS125MYQ), SilentDrive™ Essential (MR655MYQ), SilentDrive™ Elite (MR855MYQ), Commander Ultimate (MJ3800MYQ), Commander MyQ, WhisperDrive, TiltMaster, PowerAce, CyclonePro, OverDrive, SilentDrive Elite & Much much more!

MERLIN FOB REMOTE - 4-Channel



Art. E970M

PRODUCT DESCRIPTION
Capable of coding both Merlin+ and Merlin+ 2.0 Motors

PRODUCT SPECIFICATION:
Suits models: Commander Essential (MS65MYQ), Commander Elite (MS105MYQ), Commander Extreme (MS125MYQ), SilentDrive™ Essential (MR655MYQ), SilentDrive™ Elite (MR855MYQ), Commander Ultimate (MJ3800MYQ), Commander MyQ, WhisperDrive, TiltMaster, PowerAce, CyclonePro, OverDrive, SilentDrive Elite & Much much more!

CHAMBERLAIN Universal 2-Channel



Art. MC100AML

PRODUCT DESCRIPTION

Chamberlain universal remote
Controls up to two garage doors or gates
Compatible with a large range of remotes
Includes Battery & key ring

PRODUCT SPECIFICATION:
Number of Buttons: 2
Colour: Black
Suits models: Merlin M-500, M-501 & M-502 receivers
Frequency: Multiple
Battery Type: Coin Battery (CR2032)

BOSS 2-Channel



Art. BHT4

PRODUCT DESCRIPTION

Guardian BOSS Remote
2 channel remote
Controls up to two different doors or gates
Includes Battery, Wall mount & Sunvisor clip

PRODUCT SPECIFICATION:

- Compatible with BOSS 2211L-1, BOSS 2211L-2, STEEL-LINE 2211L-SL, CENTURION 2211L-C, LYNX 2211L-C-1, LYNX 2211L-C-2, LYNX 2211L-C-3, MODERN 2211L-M, GUARDIAN BHT3-S, GUARDIAN BHT3

STEEL-LINE ZT-07 - 4 CHANNEL



Art. ZT-07

PRODUCT DESCRIPTION
Steel Line
Controls up to four garage doors or gates

PRODUCT SPECIFICATION:

- Number of Buttons: 4
- Battery: LR23A
- Colour: Chrome outer, black inner body, Red buttons
- Suits models: SD800

BFT MITTO 4-Channel Garage Remote



Art. BRCB04

PRODUCT DESCRIPTION

BFT MITTO remote
4 channel remote
Control up to 4 x different garage or gates

PRODUCT SPECIFICATION:

- Compatible with BRCB02, MITTO2, MITTO4, MITTO4-B, MITTO4US, TRC1, TRC2, TRC4, MITTO2A, MITTO4A

SCAN TO SEE THE FULL GARAGE & GATE RANGE ON

sglocks.com.au





JMA is the largest producer of original keys in Europe, and holds a pre-eminent position within the global key industry, offering a wide range of quality products and services to its customers all over the world.

JMA has four production plants which are devoted exclusively to key manufacturing, being able to produce 2.5 million keys per day, and keeping around 60,000 different key references in process.

In addition, JMA is the first key manufacturer to meet the ISO 9000 Quality Standard. "JMA has the Experience of a Market Leader."

TRI-CODE - UNIVERSAL REMOTE

4 MLAA EXPO 2022

FEATURED PRODUCT TRAINING SESSION

Friday 21 October 2022
4:00 pm - 5:00 pm
Beechmont 1

JMA Universal Remote Generation - Expand your G&G remote coverage with only 2x remotes!

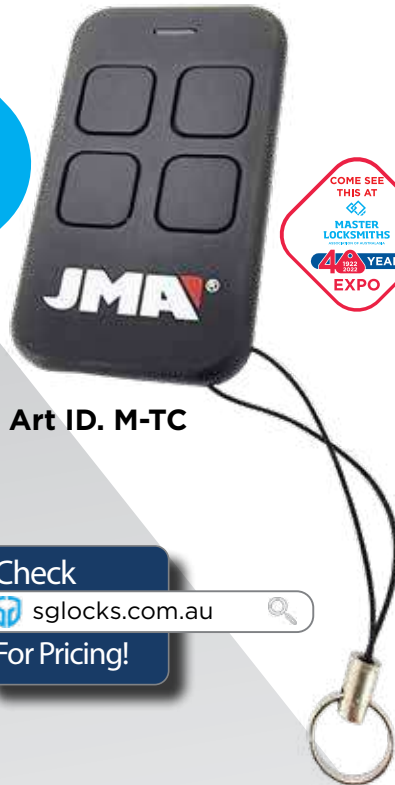

Art ID. M-TC



PRODUCT DESCRIPTION

JMA M-TC TRI-CODE Universal remote, is a compact, durable remote that is compatible with ATA Triocode and B&D Tri-Tran Garage & Gate Motors.

The MT-C comes with a Pre-coded default coding type to suit ATA TrioCode Remotes.

The MT-C Can easily be converted to a B&D Remote by:

Holding down the top 2 x buttons (1&2) on the MT-C Remote. The LED will turn on, After 4 seconds, LED will Turn Off Release the buttons, The coding has now been switched successfully The remote is registered into the ATA or B&D receiver using the factory manual procedure

PRODUCT SPECIFICATIONS

- 4-Buttons
- Frequency: Triple Frequency.433.92, 433.47 &434.37
- Replaces PTX5 and B&D Tri-Tran Remotes
- Battery Type: Coin Battery (CR2032)

Replaces below:



PTX5_{v2}

062731

Check sglocks.com.au For Pricing!

DUPLICATING REMOTE - Fixed & Rolling



Art ID. M-BT

PRODUCT DESCRIPTION

JMA M-BT Duplicating remote – see videos below to see how simple duplicating remotes can be

Capable of cloning and duplicating a wide range of FIXED and ROLLING code remotes

Using the JMA REMOTES PRO phone App, you can generate and copy remotes via Bluetooth.

Capable of integrating codes for 4 different original remotes on 1 device

PRODUCT SPECIFICATIONS

- 4-Buttons
- Frequency: 433 – 868 Mhz
- Battery Type: Coin Battery (CR2032)

Check sglocks.com.au For Pricing!





Art. BERNA

Compact Semi-Auto Key Duplicator



PRODUCT DESCRIPTION

The BERNA is a compact, durable machine that is especially suited for a Locksmith shop

It combines simplicity and versatility to easily duplicate flat keys for cylinder locks, vehicle keys, cruciform keys and even specialty keys using its special 4-sided clamps.

PRODUCT SPECIFICATIONS

- Size : 340 x 234 x 435 mm
- Weight : 17 Kg.

Scan to see the product page



Check
sglocks.com.au
For Pricing!

Art. NEO

Compact track (wave) key duplicator



PRODUCT DESCRIPTION

The NEO is the machine that brings precision and simplicity together when copying laser and special keys. It brings new features to its class, such as LED lighting and the protective screen in the work area. This machine has a special jaw to grip a huge variety of laser keys with no need for an adaptor.

PRODUCT SPECIFICATIONS

- Size (W X H X D): 240 x 380 x 350 mm
- Weight: 17 Kg

Scan to see the product page



Check
sglocks.com.au
For Pricing!

Art. NOMAD

Lightweight & Compact Duplicating Machine



PRODUCT DESCRIPTION

The NOMAD is Designed & built for the mobile Locksmith. Precision, lightweight & compact. Features include:

- Micrometric Adjustments
- 4 Way Ergonomic Jaws
- XL Jaw Distance (92mm)
- Fluid movement of the carriage
- Nylon Abrasive brush

PRODUCT SPECIFICATIONS

- Size: (W X H X D): 266 x 215 x 165 mm
- Weight: 6.5 Kg

**BEST SELLING
VAN DUPLICATOR**

Scan to see the product page



Check
sglocks.com.au
For Pricing!



INSTACODE COMPATIBLE

MULTICODE IS NOW COMPATIBLE WITH
INSTACODE PC VERSION



TOOL HOLDER

STORE ALL YOUR TOOLS CONVENIENTLY
BY USING THE TOOL HOLDER INCLUDED
WITH THE MACHINE.

KEY CUTTING IN A SINGLE MOTION

A POWERFUL MOTOR FOR CUTTING
KEYS FAST AND IN A SINGLE MOTION



4-WAY ERGONOMIC JAWS

HIGH QUALITY STEEL JAWS FOR PRECISION CUTTING. FOUR
WAY JAWS ALLOW GREATER EASE AND RELIABILITY IN THE
CLAMPING OF THE KEYS

INTERCHANGEABLE CLAMPS

CLAMP FOR SECURITY KEYS WITH INTERCHANGEABLE CLASPS. THE INNOVATIVE
DUAL-USE SYSTEM FOR EACH CLASP, ALLOWS EASY CONFIGURATION & GREATER
COMPATIBILITY WITH MORE KEY TYPES.



MULTIFUNCTIONALITY



CUTS FLAT, LASER & DIMPLE KEYS
DUPLICATE BY DECODE & CUT
SEARCH BY BRAND
KEY BLANK OR CODE
FAST START UP TIME

TOUCHSCREEN TABLET & NEW JMA SOFTWARE

JMAKEYPRO APP IS OPERATED THROUGH A TOUCHSCREEN TABLET & INCLUDES THE ENTIRE CATALOGUE OF JMA KEYS AND THEIR EQUIVALENTS.

WORK SAFELY & CLEANLY

TO GUARANTEE YOUR SAFETY, THE PROTECTIVE SCREEN AND THE TRAY FOR COLLECTING METAL SHAVINGS PREVENT THE MACHINE FROM OPERATING WHILE THEY ARE OPEN

Check

 sglocks.com.au 

For Pricing!

TECHNICAL DATA

<i>Prismatic cutter (flat keys)</i>	<i>High speed steel* 1100rpm</i>
<i>Cylindrical cutter (security keys)</i>	<i>Carbide 12000rpm</i>
<i>Standard clamp (flat keys)</i>	<i>4-faced MP1</i>
<i>Clamp for dimple or sidewinder keys</i>	<i>2-faced interchangeable claws</i>
<i>Width</i>	<i>427mm</i>
<i>Height with tablet support mount</i>	<i>612mm</i>
<i>Height without tablet support</i>	<i>431mm</i>
<i>Depth</i>	<i>413mm</i>
<i>Weight</i>	<i>27Kg</i>
<i>Effective travel</i>	<i>X = 45mm / Y = 45mm / Z = 30mm</i>

MOTOR DATA

<i>Multicode</i>	<i>24V d.c-7,5 Amp.-180W</i>
------------------	------------------------------



SEE IT FIRST
AT MLAA EXPO
2022

JMA[®]

NEW

EVO XPERT





THE ALL-IN-ONE MACHINE FOR VEHICLE KEY CLONING

GREAT CLONING CAPACITY

LATEST TECHNOLOGY READY FOR FUTURE UPDATES of new transponder models

REMOTE CONTROLS PRE-PROGRAMMING

CREATE MORE THAN 600 REFERENCES of original remote controls

WITH THESE 3 NEW JMA REMOTES



MANAGE YOUR EVO XPERT ONLINE

NO NEED TO INSTALL ANY SOFTWARE Just connect into the Internet

WORK FROM YOUR MOBILE PHONE, TABLET OR PC

STEP-BY-STEP WORK

TAKE CONTROL OF THE UPDATES Just download the ones you need

FREEDOM TO WORK WHEREVER YOU NEED

BATTERY POWERED Wireless operation

CONNECT TO THE WEB APP From anywhere with any device





Since 2009, KEYDIY has been the go-to aftermarket solution for Automotive Remotes.

The KEYDIY system can generate automotive remotes for 58 different makes of vehicle and 1000's of different models. KEYDIY also provide over 60 flip key blades to suit over 25 vehicle makes. With four R&D teams located in Israel, England, Mexico and China, there is always a new development or breakthrough over the horizon.

The quality of the KEYDIY Remotes is second to none, with many users commenting that they are better than their original remote.

60+
KEYDIY
REMOTE
TYPES
IN STOCK



**FULL RANGE COMPLIANCE TESTED BY
INDEPENDENT THIRD-PARTY NATA ACCREDITED
TESTING LABORATORIES**



**BSC - DECLARATION OF COMPLIANCE
CERTIFICATES ON FULL RANGE**



**ALL REMOTES COME WITH A FREE
MAXELL BATTERY**



BATTERY SAFETY COMPLIANT



**ALL REMOTES COME WITH END-USER
PACKAGING TO PROVIDE TO YOUR CUSTOMER
ON COMPLETION OF SALE.**



REMOTE GENERATION, FREQUENCY READER,

TRANSPONDER PRODUCTION & CLONING

NOW DOES PC ONLINE REMOTES STAND ALONE (INTERNET REQUIRED)

"The KEYDIY KD-MAX is the latest innovation for remote and transponder generation. Combining the portability and functionality of the KD-X2 with the convenience and versatility of the Mobile KD software database into one powerful device."

High Frequency Induction Area

- Special Remote Cloning Functionality
- Generates KEYDIY B, NB and ZB series remotes

Transponder Cloning

- Fixed Code - ID11, 12, 33 etc
- Texas Fixed - 4C
- Texas Crypto - 4D
- Texas Crypto - Toyota 'G'
- Texas Crypto DST - 70/83 (80 bit)
- Philips Crypto - ID46
- Megamos Crypto - ID48 (96 bit)
- Toyota 'H' Cloning

Chip generation

- Philips: ID40/44
- Texas - ID 4C
- Texas Crypto- 4D (ID60- 71)
- Texas Crypto - Toyota 'G'
- Texas Crypto DST -70/83 (80 bit)
- Fixed code - ID11, 12, 33 etc
- Philips Crypto - ID46
- Megamos Crypto-ID48 Pre-coding
- Toyota 'H' (8A) Generation



Ignition Coil Detector

- Diagnose Immobiliser Data transmission issues
- Sniff data for ID46 & ID48

Portable Design

- 5 Inch LCD Touch Screen w/ a 1280*720P Resolution
- 3375 mAh Rechargeable Battery
- Normal Working Hours >8 Hours
- Standby time > 7 Days
- Camera
- Flashlight function

Art. KD-MAX

Check

sglocks.com.au

For Pricing!

Other functions

- Identify transponder
- Remote Copy
- Check frequency
- Coin Battery tester
- Reset OEM PCB for re-use

Compatible Transponders

Art.	Description	Indiv. Price (ex. GST)	BUY PRICE Price ea. (ex. GST)
LKP02	Clone & generate Texas - ID 4C Texas Crypto- 4D (ID60- 71) Texas Crypto - Toyota 'G' Texas Crypto DST -70/83 (80 bit)	CFP	CFP
IDT5	Clone & Generate Fixed code - ID11, 12, 33 etc	CFP	CFP
CN3	Clone & Generate Philips Crypto - ID46	CFP	CFP
CN6	Clone & Generate Megamos Crypto -ID48	CFP	CFP
ID-KDH	Clone & Generate Megamos Crypto -TOY 'H' (8A)	CFP	CFP

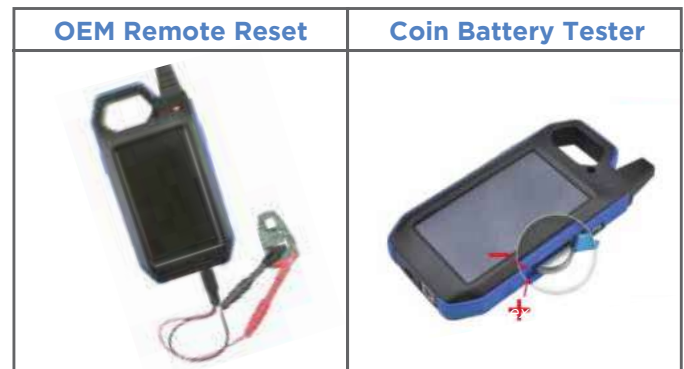



LOCKDECODERS are a specialist organisation dealing in the sales and development of sophisticated Automotive Key Cutters, versatile Transponder Cloning machines and high-quality Engravers since 2007.

Founded in England by local Automotive Locksmiths, LOCKDECODERS are dedicated to developing only the highest quality tools for the locksmithing industry, driven by their philosophy to provide "Tools That Really Work".

Use your own PC, Tablet or phone



miracle A9-EA-L AUTO-lite

PRODUCT DESCRIPTION

- Connects to InstaCode
- Improved Noise Reduction Technology with Low-vibration Design
- Wireless (WIFI) Update Function
- Supplied with Automotive Key Vice
- Creates new keys from code
- Cuts 2 track & 4 track Laser Automotive Keys
- Also cuts Single and Double sided Auto Keys
- LED illuminated cutting area
- 27W DC Motor for a fast cut cycle
- Manual Operation Function
- Compact design for easy portability
- 2 Year Manufacturer Warranty
- Can be Upgraded to an A9E with the purchase of the Domestic Jaw (A9.DOM-VICE)

PRODUCT SPECIFICATION

- Size (W X H X D): 276 x 353 x 341 mm
- Weight: 19.5 Kg
- Spindle Motor Power: 24V (27W)
- Main Power: 240V (50/60Hz)



Compatible with:



SPECIAL PRICE!

Check
sglocks.com.au
 For Pricing!

Also Available:

Art.	Description	Price ex. GST
A9-EA	Auto code cutting machine - Comes with tablet	CFP
A9-E	Auto & Domestic code cutting machine - Comes with tablet	CFP

L3-30 LASER ENGRAVER

PRODUCT DESCRIPTION

The L3-30 is the latest Fiber Laser Engraver from LDC. The L3 series Engravers are professional Engravers perfectly suited to Locksmiths or similar that require a compact high quality commercial Laser Engraver, for fast engraving on items like Restricted Keys, Dog Tags, Scar Plates, Cylinders, Padlocks and 1000's of other things.

- Fast, Quiet & Accurate
- Advanced Laser technology
- Laser Marking & Cutting
- Minimizes installation space due to compact size (can be placed on table)
- Safety Cover automatically closes when engraving is commenced & opens when finished.
- Black / White engraving options
- Internal camera enhances design process
- Laser auto focusing automatically finds the focus point
- Vacuum is automatically turned on & off as needed (very quiet) vacuum intakes dust and fumes keeping the work area clean and safe
- NEW easy to use **Magic Art 7** Software (Included)
- The sight protection glass on the safety door protects users when looking at the engraving job

PRODUCT SPECIFICATION

- Max Material Height 100mm
- Internal chamber area 350mm(W) x 100mm(H) x 170mm(D)
- Max Material Weight: 20kg
- Air Cooling
- Laser Power: 30W
- Class 1 Laser
- Size (W X H X D): 404 x 556 x 590 mm
- Machine Weight: 46Kg



Check
sglocks.com.au
 For Pricing!

magic2S

Compact engraving

PRODUCT DESCRIPTION

Magic-2S engraves texts and images on almost every metal surface (brass, steel, hardened steel, stainless steel, nickel silver etc.) with its diamond tipped engraving tip.

The Magic-2S is:

- Light Weight & Compact Size
- Sophisticated Design
- Quiet
- Portable
- Easy to use
- Wireless operations
- Compatible with PC or Tablet
- Laser pointer for easy job setup

PRODUCT SPECIFICATION

- Size (W X H X D): 258 x 274 x 339 mm
- Weight: 15Kg
- Power Supply: 240v 50/60Hz
- Tool Type: Diamond Tip
- Engraving Area: 105mm x 100mm



Check
sglocks.com.au
 For Pricing!



The LOCKTON range of security products is made from the highest quality materials with state-of-the-art manufacturing and quality control. With a comprehensive and ever-growing range of commercial hardware including; door locks, padlocks, door closers, mortice locks as well as electronic door locks and other categories. LOCKTON has a solution for your locking needs.

The Griffin is a mythical creature, part lion and part eagle, which has been known throughout history as a protector and guardian. The Griffin is symbolic of both power and bravery & is often portrayed as guarding treasure or wealth. LOCKTON & Its Griffin - Your protector & guardian and the flagship brand for SG Lock & Security.

Commercial Mortice Lock

Narrow Stile

23mm Backset

Art. SG-SBML-23

Suitable for use in all heavy traffic areas including:

- Commercial
- Education
- Retail
- Industrial
- Medical



ALSO AVAILABLE:



30mm Backset Mortice Lock
Art.SG-SBML30

5 Year Warranty



RANGE DESCRIPTION

Suits both Art. SG-SBML23 & Art. SG-SBML30 and retrofits most existing Narrow Stile Furniture

RANGE SPECIFICATION

- Material: Solid Brass (Body & Handle)
- Non-Handed
- Quality Return Spring



Art. NSQ-01C-25-SCP
External Square Plate with Cylinder Hole & Lever

Art. NSQ-01V-25-SCP
Internal Square Plate with Cylinder Hole & Lever

Art. NSQ-02C-25-SCP
External Square Plate with Lever Only

Art. NSQ-02V-25-SCP
External Square Plate with Lever Only



Art. NSQ-04C-SCP
External Square Plate with Cylinder Hole Only

Art. NSQ-04V-SCP
Internal Square Plate with Cylinder Hole Only

Art. NSQ-13VDA-25-SCP
Internal Square Plate with DA Turn Snib & Lever

Art. NSQ-13V-25-SCP
Internal Square Plate with Turn Snib & Lever



Art. SG-LT260-FP-SSS
TIMBER face plate - suits LOCKTON SG-SBML23



Art. SG-MLEXT-150SP
EXTENDED Spindle suits all LOCKTON SG Mortice Locks



Art. SG-MLSP-SP
Standard Half Spindle & Spring Pack is suitable for our range of LOCKTON mortice locks



ROUND END FURNITURE FULL RANGE ALSO AVAILABLE

5 Year Warranty



Commercial Mortice Lock

60mm Backset

Art. SG-ML60

Suitable for use in all heavy traffic areas including:

- Commercial
- Education
- Retail
- Industrial
- Medical



60mm Backset Mortice Lock - Deadbolt
Art. SG-ML60-DB

60mm Backset Mortice Lock - Sliding
Art. SG-ML60-SLD

5 Year Warranty



4- Hour Fire Rating



Art. SQ-01C-25-SCP
External Square Plate with Cylinder Hole & Lever



Art. SQ-01V-25-SCP
Internal Square Plate with Cylinder Hole & Lever



Art. SQ-02C-25-SCP
External Square Plate with Lever Only



Art. SQ-02V-25-SCP
Internal Square Plate with Lever Only



Art. SQ-04C-SCP
External Square Plate with Cylinder Hole Only



Art. SQ-04V-SCP
Internal Square Plate with Cylinder Hole Only



Art. SQ-13VDA-25-SCP
Internal Square Plate with DA Turn Snib & Lever



Art. SQ-13V-25-SCP
Internal Square Plate with Turn Snib & Lever



Art. SQ-53C-25-SCP
External Square Plate with Emergency Turn Indicator & Lever



Art. SQ-03C-25-SCP
External Square Plate with Emergency Turn & Lever



Art. SQ-06VDA-SCP
Internal Square Plate with DA Turn Snib only

RANGE DESCRIPTION
Suits Art. SG-ML60 & retrofits most 60mm Australian Mortice Locks

RANGE SPECIFICATION

- Material: Solid Brass (Body & Handle)
- Handing: Easy change handing
- Quality Return Spring



ROUND END FURNITURE
FULL RANGE ALSO AVAILABLE



5 Year Warranty

DOOR CLOSERS



'100 Series' DOOR CLOSER - Rack & Pinion (2/3/4)

PRODUCT SPECIFICATION:



- SGDC100-S Door Closer
- Rack & Pinion operation
- Non-handed
- Comes with Standard arm
- Parallel Arm Bracket
- Mounting hardware
- Simple to read installation instructions
- ** Hold open arm - Optional Accessory**
- Closing range 180° - 15°
- Latching speed range 15° - 0°
- Suitable for door sizes 2/3/4 by template adjustment
- Size #2: Door width of 850mm & Weight of 40kg
- Size #3: Door width of 950mm & weight of 60kg
- Size #4: Door width of 1100mm & Weight of 80kg
- 5 year warranty

Art. **SGDC100-S**

'150 Series' DOOR CLOSER - Rack & Pinion - (2/3/4)

PRODUCT SPECIFICATION:



- SGDC150-S Door Closer
- Rack & Pinion operation
- Non-handed
- Comes with Standard arm
- Parallel Arm Bracket
- Mounting hardware
- Simple to read installation instructions
- ** Hold open arm - Optional Accessory**
- Closing range 180° - 15°
- Latching speed range 15° - 0°
- Suitable for door sizes 2/3/4 by template adjustment
- Size #2: Door width of 850mm & Weight of 40kg
- Size #3: Door width of 950mm & weight of 60kg
- Size #4: Door width of 1100mm & Weight of 80kg
- 5 year warranty

Art. **SGDC150-S**

'160 Series' DOOR CLOSER - Rack & Pinion - (2-4)

PRODUCT SPECIFICATION:



- SGDC160-S Door Closer
- Rack & Pinion operation
- Non-handed
- Comes with Standard arm
- Parallel Arm Bracket
- Mounting hardware
- Simple to read installation instructions
- ** Hold open arm - Optional Accessory**
- Closing range 180° - 15°
- Latching speed range 15° - 0°
- Suitable for door sizes 2-4
- Size #2: Door width of 850mm & Weight of 40kg
- Size #3: Door width of 950mm & weight of 60kg
- Size #4: Door width of 1100mm & Weight of 80kg
- 5 year warranty
- Fire Rated AS1905, As1530

Art. **SGDC160-S**



'165 Series' DOOR CLOSER - Rack & Pinion - (2-6)

PRODUCT SPECIFICATION:

- SGDC165-S Door Closer
- Rack & Pinion operation
- Non-handed
- Comes with Standard arm
- Parallel Arm Bracket
- Mounting hardware
- Simple to read installation instructions
- ** Hold open arm - Optional Accessory**
- Closing range 180° - 15°
- Latching speed range 15° - 0°
- Suitable for door sizes 2-6
- Size #2: Door width of 850mm & Weight of 40kg
- Size #3: Door width of 950mm & weight of 60kg
- Size #4: Door width of 1100mm & Weight of 80kg
- Size #5: Door width of 1250mm & Weight of 100kg
- Size #6: Door width of 1400mm & Weight of 120kg
- 5 year warranty
- Fire Rated AS1905, As1530

Art. **SGDC165-S**



'190 Series' DOOR CLOSER - Cam Action - PULL (1-4)

PRODUCT SPECIFICATION:

- SGDC190-S Door Closer
- Cam Action
- B-Type - Pull side of the door fixing & Push side transom fixing
- G-Type - Push side of the door fixing & Pull side transom fixing
- **Optional Hold open insert**
- Mounting hardware
- Simple to read installation instructions
- Closing range 180° - 15°
- Latching speed range 15° - 0°
- Suitable for door sizes 1-4
- Size #2: Door width of 850mm & Weight of 40kg
- Size #3: Door width of 950mm & Weight of 60kg
- Size #4: Door width of 1100mm & Weight of 80kg
- 5 year warranty
- Fire Rated AS1905, As1530
- Tested & certified to BS EN 1154:1997

Art. **SGDC190-S-B**
(PULL)

Art. **SGDC190-S-G**
(PUSH)



'195 Series' DOOR CLOSER - Cam Action - PULL (1-5)

PRODUCT SPECIFICATION:

- SGDC195-S Door Closer
- Cam Action
- B-Type - Pull side of the door fixing & Push side transom fixing
- G-Type - Push side of the door fixing & Pull side transom fixing
- **Optional Hold open insert**
- Mounting hardware
- Simple to read installation instructions
- Closing range 180° - 15°
- Latching speed range 15° - 0°
- Suitable for door sizes 1-5
- Size #2: Door width of 850mm & Weight of 40kg
- Size #3: Door width of 950mm & weight of 60kg
- Size #4: Door width of 1100mm & Weight of 80kg
- Size #5: Door width of 1100mm & Weight of 100kg
- 5 year warranty
- Fire Rated AS1905, As1530
- Tested & certified to BS EN 1154:1997

Art. **SGDC195-S-B**
(PULL)

Art. **SGDC195-S-G**
(PUSH)

PANIC BARS

'Available in rim & vertical types to suit a wide variety of applications & configurations'

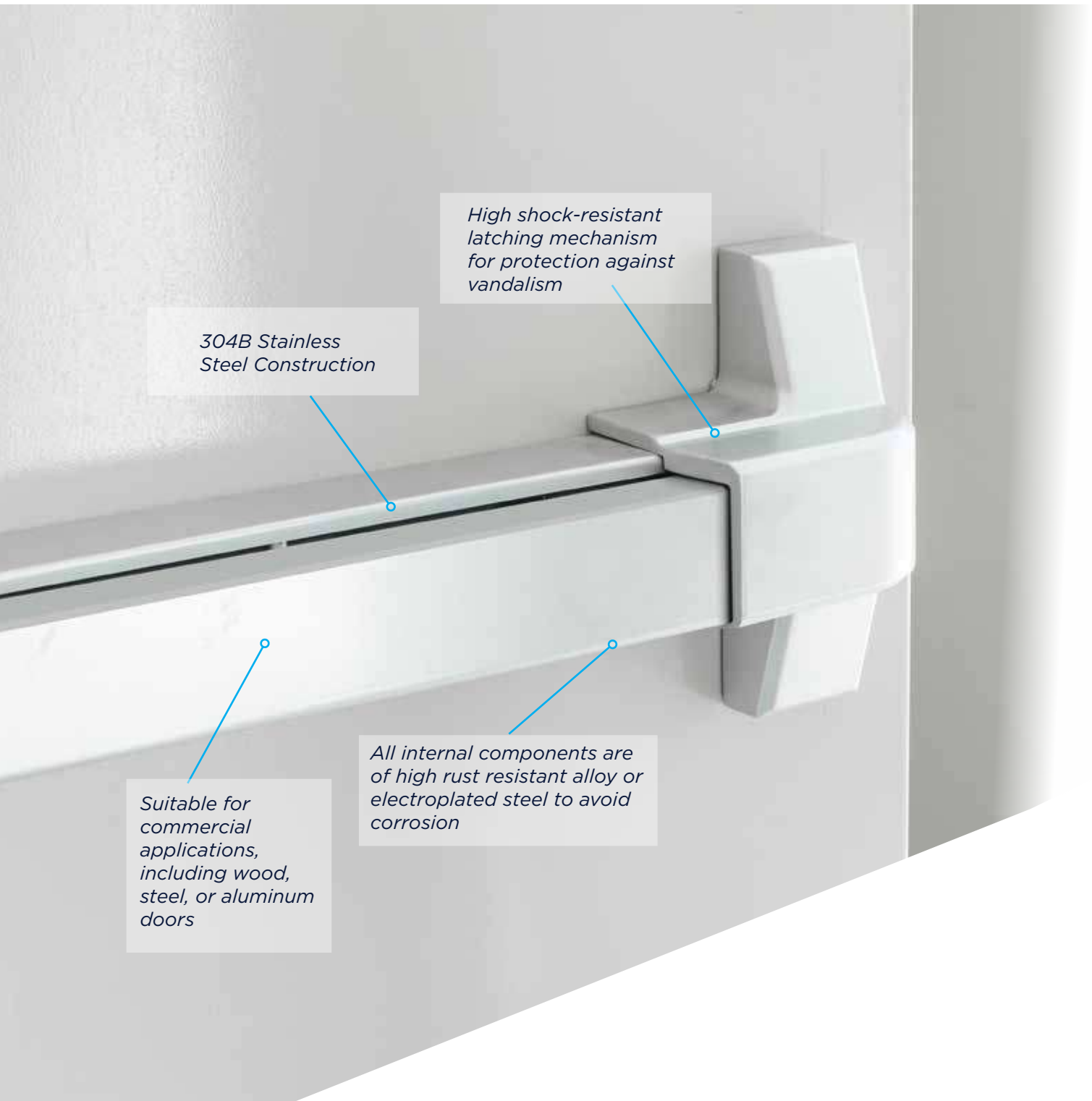

304B Stainless Steel Construction

High shock-resistant latching mechanism for protection against vandalism

Suitable for commercial applications, including wood, steel, or aluminum doors

All internal components are of high rust resistant alloy or electroplated steel to avoid corrosion

NEW

DOUBLE DOOR PANIC EXIT KITS

NEW

Panic Exit DOUBLE DOOR KITS 'STANDARD' Door sizes

PRODUCT SPECIFICATION:

- Complies with BS EN1125
- Surface mount installation
- 304B Stainless steel construction
- High Shock resistant latching mechanism
- All inside components are of high rust resistant alloy & heavily electroplated steel to avoid corrosion
- NON Handed
- Alternative external access options available
- Compatible with 201 "Round" Cylinder for exterior access
- Latch automatically dead latches when door is closed
- Single Point Panic Bar - width 820mm
- Double Point Panic Bar - width 900mm
- Suits standard door size (820mm) can be cut down up to 170mm to suit smaller doors
- Dogging - hold back function with Allen key slot in internal push bar (Non - Fire rated model only)



KIT INCLUDES:

- Single Point Panic Bar
- Double Point Panic Bar
- Overlapping Strike



STANDARD DOOR SIZE KITS

Art ID.	Description	Price
SGPD250-DDKIT	Panic Exit DOUBLE DOOR KIT - Standard Door sizes - w/ Hold Back Function - Inc. 2 x Panic Bars & 1 x Overlapping Strike	CFP
 SGPD250-F-DDKIT	'FIRE RATED' Panic Exit DOUBLE DOOR KIT - Standard Door Sizes - Inc. 2 x Panic Bars & 1 x O/Lap. Strike	CFP

NEW

Panic Exit DOUBLE DOOR KITS 'WIDE' Door sizes

PRODUCT SPECIFICATION:

- Complies with BS EN1125
- Surface mount installation
- 304B Stainless steel construction
- High Shock resistant latching mechanism
- All inside components are of high rust resistant alloy & heavily electroplated steel to avoid corrosion
- NON Handed
- Alternative external access options available
- Compatible with 201 "Round" Cylinder for exterior access
- Latch automatically dead latches when door is closed
- Single & Double Point Panic Bar - width 1120mm
- Suits standard door size (1120mm) can be cut down up to 170mm to suit smaller doors
- Dogging - hold back function with Allen key slot in internal push bar (Non - Fire rated model only)



KIT INCLUDES:

- Single Point Panic Bar
- Double Point Panic Bar
- Overlapping Strike



WIDE DOOR SIZE KITS

Art ID.	Description	Price
SGPD250-WD-DDKIT	Panic Exit DOUBLE DOOR KIT - Wide Door sizes - w/ Hold Back Function - Inc. 2 x Panic Bars & 1 x Overlapping Strike	CFP
 SGPD250-WD-F-DDKIT	'FIRE RATED' Panic Exit DOUBLE DOOR KIT - Wide Door Sizes - Inc. 2 x Panic Bars & 1 x O/Lap. Strike	CFP



4th MLAA EXPO 2022

FEATURED PRODUCT TRAINING SESSION

Friday 21 October 2022
 12:00 pm - 1:00 pm
 Beechmont 1
 Smart Entry Basics - Simplified solutions for Emerging market demands

Smart Door Lock
 Art. **ELEV64**

COME SEE THIS AT
MASTER LOCKSMITHS
 4th YEAR EXPO 2022



The fingerprint sensing area is perfectly located on the lever to naturally read a thumb print for quick entry & can store up to 100 x individual fingerprints

Emergency Key Override



Pin Code touch pad with ability to store 100 x Individual User Codes (permanent or temporary)



Battery Life 12 months or Approximately 10,000 x Openings



Use and Manage the ELEV64 via Phone App. Open the Lock, Add Users, Issue Temporary Codes + Lots More





ELEV64 can easily be fitted in place of most Knobsets, Leversets or Deadbolts. Additional Scar plates can be purchased to fit ELEV64 in place of a large range of other locks found in the Australian Market.

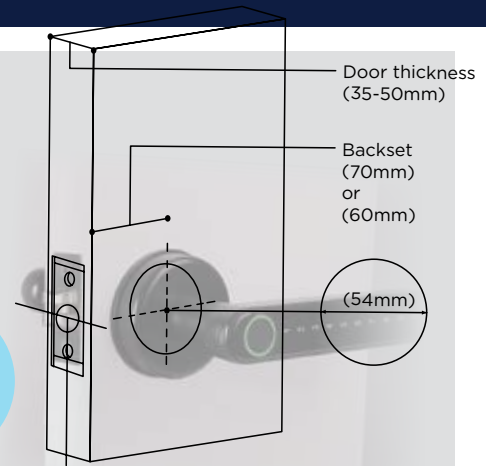

ELEV64 - APP / ADMIN FUNCTIONS

- Manage eKeys, Passcodes & Fingerprints all from within the APP
- Review Access Logs in Timeline order
- Receive 'UNLOCK' Notifications instantly
- Update the Firmware on your locks

+ Setup & Send Unlimited eKeys

Grant or Revoke Access with E-Keys. E-Keys can be Time/Period Based, Permanent, One Time, Cyclic or Customised



E-KEY / PASSCODE TYPES	EXAMPLE USER
Permanent Passcode	Owner / Administrator
Timed Passcode	Short term stays , Air BNB
One-Time Passcode	Maintenance or Delivery to property
Custom Passcode	For Family & Friends
Recurring Passcode	Baby sitter, House cleaner



ELEV64 - G2-GATE

G2 GATE is a WiFi Bridge that extends the functionality of your E-Series locks by giving the administrator Control to access remotely, from anywhere in the world!





LOCKTON 'E-Series' SMART DOOR LOCK - ELEV64



BLACK Art. ELEV64-BLK



SILVER Art. ELEV64-SIL

PRODUCT DESCRIPTION

LOCKTON 'E-Series' Smart Door Lock supports:

- Fingerprints
- Digital PIN Codes
- Mobile App functionality
- Suitable for Domestic and Office applications
- Retrofits most residential and commercial Knobsets and Leversets
- Optional G2 Gateway accessory allows for Remote access and control of lock via WiFi

PRODUCT SPECIFICATIONS

- Finish: Black or Silver
- Suitable door thickness: 35 - 50 mm
- Adjustable 60/70 mm Backset Latch
- Power Supply: 4 x AAA Alkaline Batteries
- Battery Life: Approx. 10,000 openings
- Safe Working Temperature: -20 to 50 Degrees Celsius

LOCKTON 'E-Series' WI-FI BRIDGE - G2 Gateway



Art ID. G2-GATE

PRODUCT DESCRIPTION

Optional Gateway designed to suit LOCKTON ELEV64 Smartlock. The G2-GATE enables communication with your Smartlock via Wi-Fi, allowing you to Change PIN Codes, Add Fingerprints, Create Temporary PIN Codes, Review Audit Trails and other management tasks from anywhere with an Internet connection via the TT Lock App.

PRODUCT SPECIFICATIONS

- Dimensions: 70 x 70 x 26 mm
- Network: WiFi 2.4G
- IEEE Standard: 802.11 b/g/n
- Power Connection: Type C USB
- Power Input: 5V/500mA

LOCKTON Spare OVERRIDE KEY - Suits Art. ELEV64 Smart Locks



Art ID. ELEV-KEYBLANK

PRODUCT DESCRIPTION

Spare Override Key Blank to suit LOCKTON 'E-Series' ELEV64 Smart Lock.

PRODUCT SPECIFICATIONS

- Suits: ELEV64 Smart Lock
- Material: Chrome Plated Brass



Art. ELEV64-DISP

LOCKTON 'E-Series' ELEV64 Display stand

PRODUCT DESCRIPTION:

LOCKTON E-SERIES Display Stand. Fitted with Art. ELEV64-BLK.

This Display Stand comes complete with fully functioning ELEV64 Smart Door Lock. It is the best way to showcase this Lock in your shop.

PRODUCT SPECIFICATION :

- Height: 345 mm
- Width: 190 mm
- Depth: 190 mm
- Stand Colour: Enamelled White
- Header Card: Blue LOCKTON E-Series

**Display Stand supplied
FREE with Dealer Package
Scan for more details**

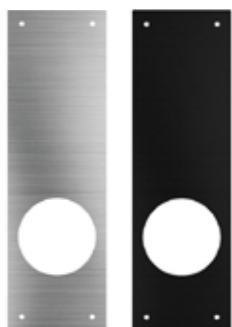

Art. **PS-REC-TNC-SS**
Art. **PS-REC-TNC-SS-BLK**

**LOCKTON - SCAR PLATE
(RECTANGLE 225x69mm) - CUT-OUT: Round 54mm Dia.**

PRODUCT DESCRIPTION:

This LOCKTON Scar Plate is designed to patch and cover up drill holes and installation points on a variety of domestic entry locksets (see compatibility below).

This plate is also designed to retrofit the LOCKTON Art. ELEV64 to provide a neat and well presented installation.

PRODUCT SPECIFICATION :

- Dimensions (L X W X T): 225 x 69 x 1.2mm
- Hole Cut-out Diameter: 54mm
- Pack Quantity: 1 x Plate
- Compatibility: Gainsborough Trilock, Lockwood Nexion and Lane Corvan



Art. **PS-RND-75-SS**
Art. **PS-RND-75-SS-BLK**

**LOCKTON - SCAR PLATE
(ROUND 75mm Dia.) - CUT-OUT: Round 54mm Dia.**

PRODUCT DESCRIPTION:

This LOCKTON Scar Plate is designed to patch and cover-up drill holes and installation points on a variety of domestic entry locksets (see compatibility below).

This plate is also designed to retrofit the LOCKTON Art. ELEV64 to provide a neat and well presented installation.

PRODUCT SPECIFICATION :

- Plate Diameter: 75mm
- Thickness: 1.2mm
- Hole Cut-Out Diameter: 54mm
- Pack Quantity: 1 x Plate



Art. **PS-RND-85-SS**
Art. **PS-RND-85-SS-BLK**

**LOCKTON - SCAR PLATE
(ROUND 85mm Dia.) - CUT-OUT: Round 54mm Dia.**

PRODUCT DESCRIPTION:

This LOCKTON Scar Plate is designed to patch and cover-up drill holes and installation points on a variety of domestic entry locksets (see compatibility below).

This plate is also designed to retrofit the LOCKTON Art. ELEV64 to provide a neat and well presented installation.

PRODUCT SPECIFICATION :

- Plate Diameter: 85mm
- Thickness: 1.2mm
- Hole Cut-out Diameter: 54mm
- Pack Quantity: 1 x Plate

REKEYABLE PADLOCKS

Have you checked out the range of LOCKTON Padlocks ?



'500 Series' 40mm PADLOCK - S/STEEL SHACKLE (KD)

PRODUCT DESCRIPTION

- 500-40-KD 40mm Padlock
- 40mm Solid brass body
- Keyed to differ
- 6.35mm Stainless steel - Quick change shackle
- Re-Keyable 6 pin cylinder
- Suits Inline restricted key systems
- Can be made from key release to key retain

Art. **500/40-KD**



'500 Series' 45mm PADLOCK - BORON SHACKLE (KD)

PRODUCT DESCRIPTION

- 500-45-KD 45mm Padlock
- 45mm Solid brass body
- Keyed to differ
- 8mm Boron - Quick change shackle
- Re-Keyable C4 6 pin cylinder
- Suitable for restricted key systems
- Can be made from key release to key retain

Art. **500/45-KD**



'500 Series' 50mm PADLOCK - BORON SHACKLE (KD)

PRODUCT DESCRIPTION

- 500-50-KD 50mm Padlock
- 50mm Solid brass body(Nickle plated)
- Keyed to Differ
- 9mm Boron - Quick change shackle
- Re-Keyable C4 6 pin cylinder
- Suitable for restricted key systems
- Can be made from key release to key retain

Art. **500/50-KD**



'500 Series' 55mm PADLOCK - BORON SHACKLE (KD)

PRODUCT DESCRIPTION

- 500-55-KD 55mm Padlock
- 55mm Solid brass body (Chrome plated)
- Keyed to differ
- 10mm Boron - Quick change shackle
- Re-Keyable C4 6 pin cylinder
- Suitable for restricted key systems
- Can be made from key release to key retain

Art. **500/55-KD**

Check

sglocks.com.au

For Pricing!



Digital Lock

Art. **MDL2100**



Easy Installation



No Batteries Required



Left or Right Handed Door



Press Button Code



Easy Combination Change



8000 Code Combinations



Holdback Option (Lock Latch Open)

LOCKTON 'Essentials' MECHANICAL DIGITAL LOCK - with Hold Back Function

PRODUCT DESCRIPTION

- LOCKTON 'Essentials' Mechanical Digital Lock designed for access control in Domestic and low traffic Commercial spaces.
- Designed to retrofit over most existing Digital Locks on the market
- Suitable for left and right handed doors.
- Ease of installation with no batteries required.
- Code change is quick and easy to achieve
- Simple and ergonomic push button design.
- Internal lever set to always open for ease of egress.
- Holdback function allows the latch to be held in the open position if required for ease of egress.
- Comes supplied with 60 mm backset Deadlatch.
- Optional 70 mm backset Deadlatches also available.

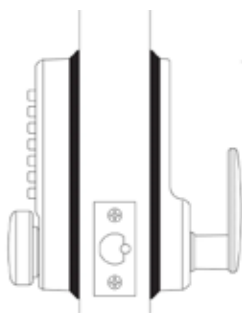

Art ID. MDL2100

PRODUCT SPECIFICATIONS

- Finish: Satin Chrome
- Suits Door Thickness: 35 - 50 mm
- Number of Code Combinations: 8,000





ML20

Restricted Key System

“A great opportunity to support your Association”

The latest Restricted Key System developed for the Master Locksmiths Association of Australasia (MLAA) and proudly supplied by SG Lock & Security.

Designed by the best in the industry with a superior key profile design that ensures the key clamps & cuts correctly and is one of the hardest inline restricted systems to manipulate on the market.

With 4 different key profiles, a massive range of 52 different barrels and a 10-year design registration on ALL 4 Key Profiles (A, B, C & M) you can provide your customer with a TRUE 10-year registration on a multi-profile site.

Design Registration until 2030

Design Registration provides 10 Years
Legal Protection against Unauthorised
Key Duplication/Production.



MLAA Trusted & Recognised Key Head

Nickel Silver - for strength!

High Quality Nickel Silver Keys
designed to be extremely strong and durable.
Precision colour inserts for easy
identification.

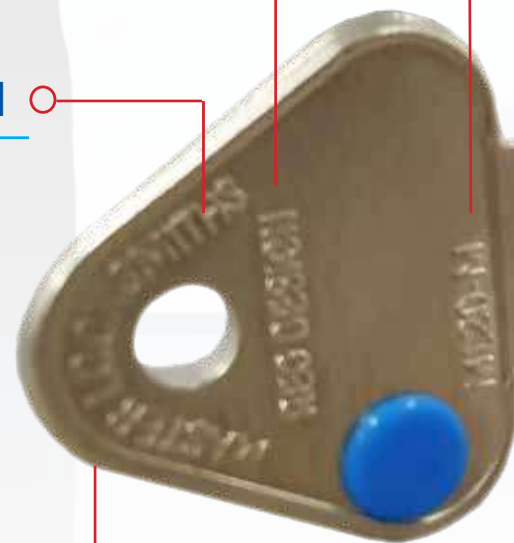

Customer Testimonial



“

As an organisation, we have been very impressed with the ML20 keying platform. The barrel range is more than ample and the assembled product works perfectly in all the housing brands (oval & night latch) that we have tried.

The ability to acquire short-run key blanks is an added feature that we've not had available from any other keying platform before.

This provides us reassurance that when we need to use another of the keyways, we can achieve this with short run blanks until our coined blanks arrive.

SG Locks have done a superb job in bringing this MLAA branded product to the market Thank you to the whole team! ”

- CLASS LOCKSMITHS



Multiple Profiles (A, B, C & M) Available NOW

The only Restricted System to cater for Large Multi-Profile Sites from Day 1.

Design & Create Systems with expansion from the very start. A, B, C & M Profiles Available Now!

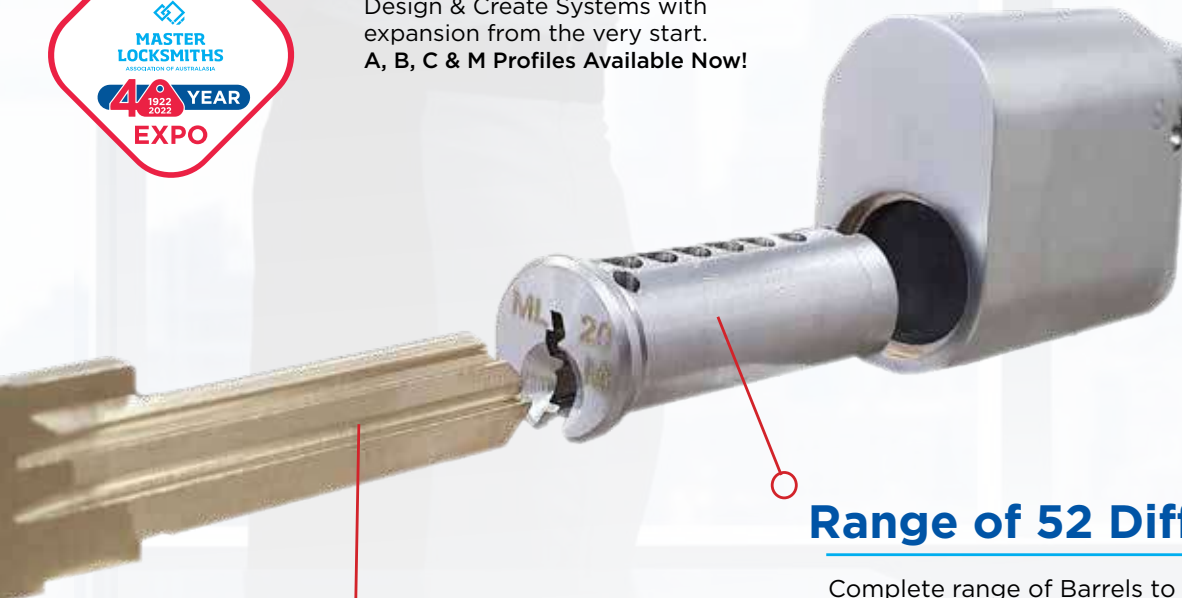

Range of 52 Different Barrels

Complete range of Barrels to suit almost every type of Lock to ensure you can get the job done!

Note: 13 different barrels in A, B, C & M Profiles.

Superior Key Design

The key profile design ensures accurate clamping & cutting every time. ML20's intricate profile designs also ensure it is one of the hardest inline Restricted systems to manipulate.

ML20 PRODUCT RANGE



Art ID	Description	Size
ML20-570-A-SC	570 Oval Cyl. BARREL - "A" PROFILE	6 Pin
ML20-570-B-SC	570 Oval Cyl. BARREL - "B" PROFILE	6 Pin
ML20-570-C-SC	570 Oval Cyl. BARREL - "C" PROFILE	6 Pin
ML20-570-M-SC	570 Oval Cyl. BARREL - "M" PROFILE	6 Pin



Art ID	Description	Size
ML20-9555-1-A-CP	9555-1 Euro Cyl. (Fixed Cam) BARREL - "A" PROFILE	6 Pin
ML20-9555-1-B-CP	9555-1 Euro Cyl. (Fixed Cam) BARREL - "B" PROFILE	6 Pin
ML20-9555-1-C-CP	9555-1 Euro Cyl. (Fixed Cam) BARREL - "C" PROFILE	6 Pin
ML20-9555-1-M-CP	9555-1 Euro Cyl. (Fixed Cam) BARREL - "M" PROFILE	6 Pin



Art ID	Description	Size
ML20-570HB-A-SC	570 Oval (Hold Back) Cyl. BARREL - "A" PROFILE	6 Pin
ML20-570HB-B-SC	570 Oval (Hold Back) Cyl. BARREL - "B" PROFILE	6 Pin
ML20-570HB-C-SC	570 Oval (Hold Back) Cyl. BARREL - "C" PROFILE	6 Pin
ML20-570HB-M-SC	570 Oval (Hold Back) Cyl. BARREL - "M" PROFILE	6 Pin



Art ID	Description	Size
ML20-9555-2-A-CP	9555-2 Euro Cyl. (Fixed Cam Turn) BARREL - "A" PROFILE	6 Pin
ML20-9555-2-B-CP	9555-2 Euro Cyl. (Fixed Cam Turn) BARREL - "B" PROFILE	6 Pin
ML20-9555-2-C-CP	9555-2 Euro Cyl. (Fixed Cam Turn) BARREL - "C" PROFILE	6 Pin
ML20-9555-2-M-CP	9555-2 Euro Cyl. (Fixed Cam Turn) BARREL - "M" PROFILE	6 Pin



Art ID	Description	Size
ML20-201-A-SC	201 Rim Cyl. (Round) BARREL - "A" PROFILE	6 Pin
ML20-201-B-SC	201 Rim Cyl. (Round) BARREL - "B" PROFILE	6 Pin
ML20-201-C-SC	201 Rim Cyl. (Round) BARREL - "C" PROFILE	6 Pin
ML20-201-M-SC	201 Rim Cyl. (Round) BARREL - "M" PROFILE	6 Pin



Art ID	Description	Size
ML20-9555-3-A-CP	9555-3 Euro Cyl. (Lazy Cam) BARREL - "A" PROFILE	6 Pin
ML20-9555-3-B-CP	9555-3 Euro Cyl. (Lazy Cam) BARREL - "B" PROFILE	6 Pin
ML20-9555-3-C-CP	9555-3 Euro Cyl. (Lazy Cam) BARREL - "C" PROFILE	6 Pin
ML20-9555-3-M-CP	9555-3 Euro Cyl. (Lazy Cam) BARREL - "M" PROFILE	6 Pin

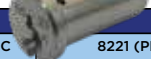

Art ID	Description	Size
ML20-8221-A-SC	8221 (PD) Cyl. BARREL - "A" PROFILE	6 Pin
ML20-8221-B-SC	8221 (PD) Cyl. BARREL - "B" PROFILE	6 Pin
ML20-8221-C-SC	8221 (PD) Cyl. BARREL - "C" PROFILE	6 Pin
ML20-8221-M-SC	8221 (PD) Cyl. BARREL - "M" PROFILE	6 Pin



Art ID	Description	Size
ML20-7105-A-CP	Blaxland Inner Cyl. BARREL - "A" PROFILE	5 Pin
ML20-7105-B-CP	Blaxland Inner Cyl. BARREL - "B" PROFILE	5 Pin
ML20-7105-C-CP	Blaxland Inner Cyl. BARREL - "C" PROFILE	5 Pin
ML20-7105-M-CP	Blaxland Inner Cyl. BARREL - "M" PROFILE	5 Pin



Art ID	Description	Size
ML20-530-A-SC	530 Cyl. BARREL - "A" PROFILE	6 Pin
ML20-530-B-SC	530 Cyl. BARREL - "B" PROFILE	6 Pin
ML20-530-C-SC	530 Cyl. BARREL - "C" PROFILE	6 Pin
ML20-530-M-SC	530 Cyl. BARREL - "M" PROFILE	6 Pin



Art ID	Description	Size
ML20-495-A-CP	Whitco Screen Door Cyl. BARREL - "A" PROFILE	5 Pin
ML20-495-B-CP	Whitco Screen Door Cyl. BARREL - "B" PROFILE	5 Pin
ML20-495-C-CP	Whitco Screen Door Cyl. BARREL - "C" PROFILE	5 Pin
ML20-495-M-CP	Whitco Screen Door Cyl. BARREL - "M" PROFILE	5 Pin



Art ID	Description	Size
ML20-001-A-SC	001 Inner Cyl. BARREL - "A" PROFILE	6 Pin
ML20-001-B-SC	001 Inner Cyl. BARREL - "B" PROFILE	6 Pin
ML20-001-C-SC	001 Inner Cyl. BARREL - "C" PROFILE	6 Pin
ML20-001-M-SC	001 Inner Cyl. BARREL - "M" PROFILE	6 Pin

KEYS



Art ID	Description
ML20-KB-A	EMBOSSED Key Blank - "A" PROFILE
ML20-KB-B	EMBOSSED Key Blank - "B" PROFILE
ML20-KB-C	EMBOSSED Key Blank - "C" PROFILE
ML20-KB-M	EMBOSSED Key Blank - "M" PROFILE

KEY INSERTS & PINS



Art ID	Description	Size
ML20-8466-A-SC	8466 Kawneer Cyl. BARREL - "A" PROFILE	6 Pin
ML20-8466-B-SC	8466 Kawneer Cyl. BARREL - "B" PROFILE	6 Pin
ML20-8466-C-SC	8466 Kawneer Cyl. BARREL - "C" PROFILE	6 Pin
ML20-8466-M-SC	8466 Kawneer Cyl. BARREL - "M" PROFILE	6 Pin

Art ID	Description	Colour
ML20-KI-BK	Coloured KEY INSERT - Black	* Black *
ML20-KI-BL	Coloured KEY INSERT - Blue	* Blue *
ML20-KI-GN	Coloured KEY INSERT - Green	* Green *
ML20-KI-OR	Coloured KEY INSERT - Orange	* Orange *
ML20-KI-PK	Coloured KEY INSERT - Pink	* Pink *
ML20-KI-RD	Coloured KEY INSERT - Red	* Red *
ML20-KI-WH	Coloured KEY INSERT - White	* White *
ML20-KI-YE	Coloured KEY INSERT - Yellow	* Yellow *
ML20-HAR-PIN	HARDENED PINS to Suit All ML20 Restricted Barrels	* Hardened Steel *



Art ID	Description	Size
ML20-TRI-A-CP	TRILOCK Cyl. BARREL - "A" PROFILE	6 Pin
ML20-TRI-B-CP	TRILOCK Cyl. BARREL - "B" PROFILE	6 Pin
ML20-TRI-C-CP	TRILOCK Cyl. BARREL - "C" PROFILE	6 Pin
ML20-TRI-M-CP	TRILOCK Cyl. BARREL - "M" PROFILE	6 Pin

*Prices may be changed at any time without further notice. Please refer to www.sglocks.com.au for our current pricing



ML20

Restricted Key System

‘Commercial Focus’
ML20
Brochure*

Customer
Facing
Brochure

Art ID: BR-COM-EU

Order now with your
Company Logo & Details

 sglocks.com.au 

* Brochures are supplied
FOC for active dealers



Founded in the early 2000's, ORIGINAL LISHI is at the forefront of Automotive Lock Picking and Decoding technology, and more recently have developed the LISHI Domestic Pick Range that has transformed the Locksmith Industry.

ORIGINAL LISHI have an extremely high-quality control and manufacturing process to help ensure that each of their tools withstand the rigors of daily use and still provides years of service.

ORIGINAL LISHI Tools are guaranteed to do what they are designed to do and all their tools are supplied with a verification code on the back of the pick. This code can be validated to ensure you are trusting your business to the Original, the Best: ORIGINAL LISHI



FEATURED PRODUCT TRAINING SESSION

Friday 21 October 2022
01:00 pm - 2:00 pm
📍 Beechmont 1

Original Lishi Training + New Tips & Tricks for Domestic

HANDS ON TRAINING

Come get 'hands on' with our ORIGINAL LISHI Tool Range, try out a range of Auto & Domestic ORIGINAL LISHI Picks. 60+ Locks from 20+ Makes/Models available, come and get hands on demonstrations / practice your skills with the SGLOCKS in-house experts



Exclusive ORIGINAL LISHI Distributor for Australia & New Zealand

140+ LISHI Picks
Stocked for
Immediate Dispatch





KIT CONTAINS Art.

1	LP-LW5-AG
2	LP-LW4-AG
3	LP-TE2-AG
4 Position Protective Case	LP-PC x 3

ORIGINAL LISHI

‘Lishi’ DOMESTIC STARTER KIT -

Includes 3 x Popular Domestic Lishi Picks

PRODUCT DESCRIPTION:

The LP-KIT-DOM-START LISHI Pick Starter Kit, is the ideal kit for anyone getting into domestic LISHI picking and decoding. The kit contains 3 x of the most popular domestic pick and decoders, making it perfect for beginners or experienced people.



Art. **LP-KIT-DOM-START**

VERIFY YOUR



KIT CONTAINS Art.

1	LP-LW5-AG	6	LP-SC1-AG
2	LP-LW4-AG	7	LP-KW1-AG
3	LP-TE2-AG	8	LP-KW5-AG
4	LP-TE2-AG	4 Position Protective Case	LP-PC x 8
5	LP-SC4-AG		

ORIGINAL LISHI

‘Lishi’ DOMESTIC ADVANCED KIT -

Includes 8 x Popular Domestic Lishi Picks

PRODUCT DESCRIPTION:

The LP-KIT-DOM-ADV LISHI Pick Advanced Kit, is the ideal kit for the professional domestic locksmithing specialist. The kit contains 8 x of the most popular domestic pick and decoders, making it perfect for experienced people.



Art. **LP-KIT-DOM-ADV**

VERIFY YOUR





KIT CONTAINS Art.

1	LP-BW9-AG	11	LP-HON77-AG
2	LP-DEC-HON71	12	LP-KTM1-AG
3	LP-DEC-KW14	13	LP-KW16-AG
4	LP-DEC-SUZ14	14	LP-KYM2-AG
5	LP-DEC-YH35R	15	LP-KYM2R-AG
6	LP-DEC-YH35R-EXT	16	LP-YH35R
7	LP-HON31-AG	17	LP-YH65-AG
8	LP-HON31R-AG	18	LP-ZD30-AG
9	LP-HON41/42-AG	LEATHER CASE	LP-LTB-24
10	LP-HON63-AG		

ORIGINAL LISHI

'Lishi' BIKE KIT - Includes 18 x Bike Picks in Leather 24-Place Tool Case

PRODUCT DESCRIPTION:

The LP-KIT-BIKE LISHI Kit contains 18 x of the most popular Bike pick and decoders in a leather case that can hold a total of 24 x tools.

24-Place Leather Case



Art. LP-KIT-BIKE



SCAN
for more information
on this Kit



KIT CONTAINS Art.

1	LP-HU162-2015-AG	12	LP-NE72-AG
2	LP-HU100R-AG	13	LP-REN
3	LP-HU162-SC-I-AG	14	LP-SIP22-TL-AG
4	LP-HU162-SC3-D-AG	15	LP-VA2T-AG
5	LP-HU162-SC4-D-AG	16	LP-VA6-QL-AG
6	LP-HU66-TL-AG	17	LP-VAC102-AG
7	LP-HU58-TL-AG	18	LP-WT47T
8	LP-HU64-AG	19	LP-YM23-AG
9	LP-HU83-AG	20	LP-YM30+
10	LP-HU92-TL-AG	LEATHER CASE	LP-LTB-24
11	LP-NE66-AG		

ORIGINAL LISHI

'Lishi' EURO KIT - Includes 20 x Euro Vehicle Picks in Leather 24-Place Tool Case

PRODUCT DESCRIPTION:

The LP-KIT-EURO LISHI Kit contains 20 x of the most popular Euro Vehicle pick and decoders in a leather case that can hold a total of 24 x tools.

24-Place Leather Case



Art. LP-KIT-EURO



SCAN
for more information
on this Kit



ORIGINAL LISHI

'Lishi' TRUCK KIT - Includes 14 x Truck Picks in Leather 24-Place Tool Case

PRODUCT DESCRIPTION:

The LP-KIT-TRUCK contains 14 x of the most popular truck picks and decoders in a leather case that can hold a total of 24 x tools.

KIT CONTAINS Art.

1	LP-CY24-TRUCK-AG	9	LP-MIT8-I
2	LP-DAT12R-AG	10	LP-NSN11-AG
3	LP-GT10	11	LP-TOY38R
4	LP-H11-AG	12	LP-TOY43-IG8-AG
5	LP-HU56	13	LP-TOY43-SW8-AG
6	LP-HU71-TL-AG	14	LP-YM15
7	LP-ISU5	LEATHER CASE	LP-LTB-24
8	LP-MIT8-D		

24-Place Leather Case



Art. LP-KIT-TRUCK



SCAN
for more information on this Kit

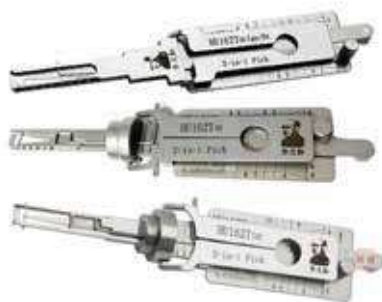

ORIGINAL LISHI

'Lishi' VAG162 Bundle - Includes 4 x HU162 Vehicle Pick Variations for All 2015+ VAG Vehicles

PRODUCT DESCRIPTION:

The LP-KIT-EURO VAG162 contains 4 x HU162 Lishi Vehicle Pick Variation's for all 2015+ VAG Vehicles.

KIT CONTAINS Art.

1	LP-HU162-2015-AG
2	LP-HU162-SC-I-AG
3	LP-HU162-SC3-D-AG
4	LP-HU162-SC4-D-AG
4 Position Protective Case	LP-PC x 4



Art. LP-KIT-VAG162



SCAN
for more information on this Kit

SGT

>>>SGT is all about Solutions

Solutions to everyday problems that the modern locksmith faces.

Solutions that make getting the job done quicker & easier.

Solutions that work !

SMART KEYS



Range of
90+

REMOTE KEYS



Range of
20+

TRANSPONDERS

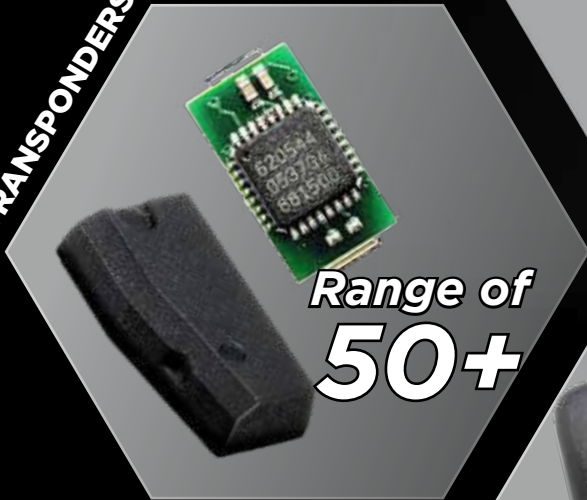

Range of
50+

KEY SHELLS



Range of
35+

KEY PROGRAMMING TOOLS



SCAN TO SEE THE FULL
>>>SGT RANGE ON

 sglocks.com.au 





Lock Pins

Specialty Products
& Manufacturing, LLC



The SP LOCK PINS range of Pins and Pinning Kits supports most of the major international Lock Brands including ASSA ABLOY, Schlage, Master Lock and many more.



Their factory in the US is home to some of the highest precision milling and fabrication machines on the market, ensuring the best possible quality in every pin they make.

NEW

TE2 GAINSBOROUGH Aftermarket Pins



PRODUCT SPECIFICATION

- Gainsborough Compatible pins (TE2)
- Type: Bottom Pin
- Material: #360 Alloy Brass (Full-Hard)
- Colour: Brass
- Packet of 144
- Made in USA

NEW

TE2 - GAINSBOROUGH AFTERMARKET PINS



Art ID	Colour	Packet (qty: 144)
GAINS-BP0	* Gold *	CFP
GAINS-BP1	* Gold *	CFP
GAINS-BP2	* Gold *	CFP
GAINS-BP3	* Gold *	CFP
GAINS-BP4	* Gold *	CFP
GAINS-BP5	* Gold *	CFP
GAINS-BP6	* Gold *	CFP
GAINS-BP7	* Gold *	CFP
GAINS-BP8	* Gold *	CFP

NEW

STANDARD Aftermarket Pins

PRODUCT SPECIFICATION

- For Standard AUS Inline Cylinders
- Type: Bottom Pin & Master pins
- Size: No. 0-9 Bottom Pins
- Size: No. 2-9 Master Pins
- Color Coated
- Material: #360 Alloy Brass (Full-Hard)
- Made in USA

COLOUR COATED BOTTOM PINS (AUS STANDARD)

Art ID	Colour	Packet (qty: 144)	Box (qty: 1000)	5x Boxes (qty: 5000)
0-BOTTOM-PIN	* Silver *	CFP	CFP	CFP
1-BOTTOM-PIN	* Gold *	CFP	CFP	CFP
2-BOTTOM-PIN	* Green *	CFP	CFP	CFP
3-BOTTOM-PIN	* Purple *	CFP	CFP	CFP
4-BOTTOM-PIN	* Red *	CFP	CFP	CFP
5-BOTTOM-PIN	* Silver *	CFP	CFP	CFP
6-BOTTOM-PIN	* Gold *	CFP	CFP	CFP
7-BOTTOM-PIN	* Green *	CFP	CFP	CFP
8-BOTTOM-PIN	* Purple *	CFP	CFP	CFP
9-BOTTOM-PIN	* Red *	CFP	CFP	CFP



COLOUR COATED MASTER PINS (AUS STANDARD)

Art ID	Colour	Packet (qty: 144)	Box (qty: 1000)	5x Boxes (qty: 5000)
2-MASTER-PIN	* Red *	CFP	CFP	CFP
3-MASTER-PIN	* Silver *	CFP	CFP	CFP
4-MASTER-PIN	* Gold *	CFP	CFP	CFP
5-MASTER-PIN	* Green *	CFP	CFP	CFP
6-MASTER-PIN	* Purple *	CFP	CFP	CFP
7-MASTER-PIN	* Red *	CFP	CFP	CFP
8-MASTER-PIN	* Silver *	CFP	CFP	CFP
9-MASTER-PIN	* Gold *	CFP	CFP	CFP

** All pricing ex. GST**

NICKEL SILVER PINS For Restricted systems

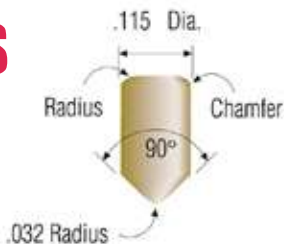
BOTTOM PINS



- Best Pins for Inline Restricted Key systems
- Type: *Nickel Silver* Bottom Pin
- Colour Coated
- Material: Nickel Silver
- Made in USA



NICKEL SILVER BOTTOM PINS (AUS STANDARD)

Art ID	Colour	Packet (qty: 100)	Box (qty: 1000)	5x Boxes (qty: 5000)
0-BOTTOM-PIN-NS	* Silver *	CFP	CFP	CFP
1-BOTTOM-PIN-NS	* Blue *	CFP	CFP	CFP
2-BOTTOM-PIN-NS	* Green *	CFP	CFP	CFP
3-BOTTOM-PIN-NS	* Purple *	CFP	CFP	CFP
4-BOTTOM-PIN-NS	* Red *	CFP	CFP	CFP
5-BOTTOM-PIN-NS	* Silver *	CFP	CFP	CFP
6-BOTTOM-PIN-NS	* Blue *	CFP	CFP	CFP
7-BOTTOM-PIN-NS	* Green *	CFP	CFP	CFP
8-BOTTOM-PIN-NS	* Purple *	CFP	CFP	CFP
9-BOTTOM-PIN-NS	* Red *	CFP	CFP	CFP

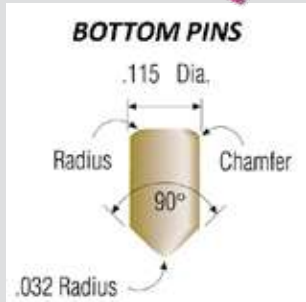

PINNING KITS



Art ID	Size/Colour	Description	Price
SGL-GAINS	9 Sizes	'Gainsborough' (TE2) BOTTOM PIN KIT - 9 Sizes in Compact Case	CFP
SGL-115	18 Sizes	'AUS' PIN KIT - MAST & BOTT PINS (0.115" Dia.) - Metal Case	CFP
SGL-115-ECON	22 Sizes+Spr./Shim	'Economy' PIN KIT - MAST & BOTT & TOP PINS (0.115" Dia.) - Plastic Case	CFP
SPK-55	113 Sizes+Spr.	'Universal' PIN KIT - 113 Sizes (0.115" Dia.) - 5/1000 Increments	CFP

** All pricing ex. GST**

To see the full range of SP Lock Pins go to

SPOOLED TOP PINS For Additional Security



- Type: Spooled Top Pin
- Top Pin designed to give additional security to inline cylinders
- Colour: Gold
- Material: #360 Alloy Brass (Full-Hard)
- Packet of 100
- Made in USA

NEW

SPOOLED TOP PIN (SECURITY PINS)



Art ID	Colour	Description	Packet (qty: 100)
155-SP-TOP-PIN	* Gold *	SPOOLED TOP PIN (0.155") - Pkt of 100	CFP
170-SP-TOP-PIN	* Gold *	SPOOLED TOP PIN (0.170") - Pkt of 100	CFP
180-SP-TOP-PIN	* Gold *	SPOOLED TOP PIN (0.180") - Pkt of 100	CFP
200-SP-TOP-PIN	* Gold *	SPOOLED TOP PIN (0.200") - Pkt of 100	CFP
240-SP-TOP-PIN	* Gold *	SPOOLED TOP PIN (0.240") - Pkt of 100	CFP



ACCESSORIES

Art ID	Size/Colour	Description	Price
SHM	S/Steel	CURVED SHIMS - Stainless Steel - Pkt of 25	CFP
SPR-L	* Bronze *	LOCK SPRINGS - Long (Standard) - Pkt of 144	CFP
SPR-S	* Bronze *	LOCK SPRINGS - Short (Standard) - Pkt of 144	CFP



TOP PINS (AUS STANDARD)



Art ID	Colour	Description	Price qty: 144	Price qty: 1000
.125-TOP-PIN	* Green *	TOP PIN *GREEN* (0.125")	CFP	CFP
.150-TOP-PIN	* Green *	TOP PIN *GREEN* (0.150")	CFP	CFP
.185-TOP-PIN	* Gold *	TOP PIN * GOLD* (0.185")	CFP	CFP
.200-TOP-PIN	* Green *	TOP PIN *GREEN* (0.200")	CFP	CFP



MX-V MAGNETIC DRILL PRESS

- **NO POWER NECESSARY**
- **SUPERIOR PERFORMANCE**
- **SMALLER FOOTPRINT**

Cordless Magnetic Drill Press MX-V with switchable magnet technology (MAGRIG), provides superior holding power, weighs less and with a smaller footprint compared to other magnetic drill presses.

Weighing in at only 7 kgs and a footprint of only 190mm x 80mm the MX-V provides **680kg HOLDING POWER** and is effective on thin and thick metal surfaces. The real surprise is it requires **NO ELECTRICITY.**

Just flip the switch to stick the rig! The rig comes standard with drill collar for popular 1/2" drills including Metabo, Bosch, Milwaukee and DeWalt corded drills. Additional collar available for the DeWalt 20V Cordless drill.

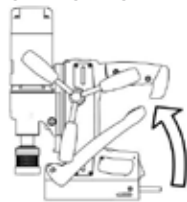
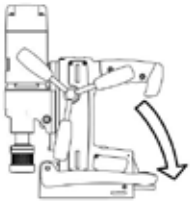

Place the MAGRIG to the safe & lock the MAGRIG in place.

Turn on the drill & slowly rotate the handles to drill into the safe.

When drilling is complete, simply release the lock & remove the MAGRIG



WATCH THE VIDEO DEMO
SCAN TO SEE HOW IT WORKS AT

Check

sglocks.com.au

For Pricing!



Minirig®

Art. #MRP

- The Pro Kit includes: the MiniRig and 2 Safe Drill Templates (for drilling S&G, LaGard and Diebold mechanical locks), Universal Dial Puller, plus a fitted Custom Case and it all weighs less than 4.5 kg.
- Precise depth control and accuracy makes safe drilling easy and more profitable. Innovative design, quality construction.
- Quick Disconnect design allows you to remove and replace the MiniRig in seconds from mounting options.
- Best of all, it can pay for itself in one or two openings!

Check

sglocks.com.au

For Pricing!

Drill Rig VACUUM MOUNT



Art. #MINIVAC

PRODUCT DESCRIPTION:

StrongArm® MiniVac - Safe Suction Attachment. The light-weight MiniVac quickly attaches the MiniRig, Bullet or Lever Bar drill rigs to safes and vaults. The MiniVac holds to most textured and smooth safe finishes with a few pushes on the pump. The 225 mm dia. soft rubber pad protects the safes paint, and an adjustable levelling arm maximises the holding power and provides drilling stability.

PRODUCT SPECIFICATION

- Diameter: 225mm

Check
sglocks.com.au
 For Pricing!

1/2" UNIVERSAL ADAPTER



Art. #MAG-MX-V.UA.500

PRODUCT DESCRIPTION:

Universal Adapter accessory allows the Strongarm MAGRIG to be used with almost every 1/2" Corded or Cordless Drill ever made. The Ball Bearing design allows for daily heavy-duty use in most strenuous applications.

PRODUCT SPECIFICATION

- The adapter's design allows for unrestrained drill pivoting, ensuring easy and comfortable positioning.
- Design also allows handle to twist away from user grip in the event of drill bit binding.

Check
sglocks.com.au
 For Pricing!

EXTENDED GUIDEWAY KIT



Art. #MAG-MX-V-EG

PRODUCT DESCRIPTION:

The Strongarm Extended Guideway Kit, designed to allow the usage of longer drill bits with the MAGRIG Drill Rig.

PRODUCT SPECIFICATION

- Compatible with: Art. MAGRIG (Please see RELATED PRODUCTS)
- Dimensions (L x W): 280mm x 80mm
- Weight: 1.1kg

Check
sglocks.com.au
 For Pricing!

Check

sglocks.com.au

For Pricing!



Founded in 2010, XHORSE is a rapidly growing technology company providing automotive security products and solutions.

Based in China they develop and produce all their products in house and are constantly researching and developing new and improved solutions for the automotive security market.

Their Key Tool Max has made waves here in Australia with its portability, functional design and universal Super Chip transponder that makes chip cloning a far more streamlined process whilst also reducing stock holdings.



SEE IT FIRST
AT MLAA EXPO
2022



NEW

KEY TOOL MAX - PRO

ART NO. *KTM-PRO*



PRODUCT DESCRIPTION

The Key Tool Max Pro is a very Powerful & Completely Stand-Alone Remote/Transponder Machine.

This new variation includes an OBDII cable, eliminating the need to purchase the XHORSE M-OBDDongle.

It also includes Battery test probes for testing voltage on a vehicles battery or the battery of a remote.

All existing purchased hardware like 8A Cable etc. can be combined with the new PRO version for existing KTM users that wish to upgrade.



ART NO. *KTM-PRO*



**SCAN TO SEE
THE KTM-PRO
IN ACTION**



HUGE RANGE OF XHORSE REMOTES ON

sglocks.com.au



SCAN TO SEE THE FULL XHORSE RANGE





SEE IT FIRST
AT MLAA EXPO
2022

NEW

KEY TOOL PLUS - ESSENTIAL

ART NO. **KT-PLUS-ES**



PRODUCT DESCRIPTION

The KEY TOOL PLUS - Essential is a great option for those wanting to upgrade their KTM whilst gaining much more expanded functionality.

This variation we offer contains the most important & most needed core features for Locksmiths Day-to-day use.

The Essential tablet can be upgraded to the full version at anytime by purchasing the software upgrade.

By excluding the more Niche software components we are able to offer the KEY TOOL PLUS -Essential at a special entry level price point for those continuing their XHORSE Journey!

And our support staff look forward to the ability to assist via Teamviewer, included on the KT-PLUS-ES

Remote Generation

- Generate Remotes that are separate to the Transponder.
- Generate Remotes that are integrated with the Transponder.
- Generate Smart/Proximity Keys.
- Transponder Cloning & Generation

Cloning Compatibility

- Texas Crypto DST+ - H key Clone
- Megamos Crypto - 8C
- Fixed Code - ID11, 12, 33, 40, 41, 42, 43, 44
- Texas Fixed - 4C
- Megamos Crypto - 8E
- Texas Crypto - 4D - (ID60- 71)
- Texas Crypto - Toyota 'G'
- Texas Crypto DST - 70/83 (80 bit)
- Philips Crypto - ID46
- Philips Crypto 2 - ID47,49 (Clone some)
- Megamos Crypto - ID48 (96 bit)

+ Advanced Transponder editing function

OBD Programming (Essentials version)

KEY TOOL PLUS supports over 20,000 car models worldwide. Easily select the car brands and car models on the immo programming interface by manufacturer name or A-Z word search.

* NOTE- BMW, MERCEDES & VW are not included in Essentials version



ART NO. **KT-PLUS-ES**

Immo Data Tool

For some cars, key programming cannot be achieved via OBD.

KEY TOOL PLUS comes with this utility to create a transponder from the vehicles eeprom file.

Use your existing eeprom reader to read the immo data, then use KEY TOOL Plus to generate an emulated transponder (XHSUP) from the file that will start the vehicle.

Hardware Technical Information:

- CPU: 8-core 2GHz
- RAM+ROM: 4G+128G
- Operation System: Android 9.0
- Screen Size: 10.1» HD Anti-glare; Anti-fingerprint. Super 10.1» anti-glare display enables top operation experience.
- Rear HD Camera: 13.0MP. The 13MP rear camera is designed to fit in multiple scenarios perfectly.
- Battery Capacity: 10000mAh. Long battery life and PD3.0 fast charge help keep you productive throughout your day.
- Charging: 30W Super Fast Charge
- Bluetooth: 5.0 Bluetooth
- WIFI: 2.4G/5G

XTOOL

A U S T R A L I A

**TRADE
IN DEAL**

UPGRADE & SAVE!



TRADE IN YOUR OLD **XTOOL-AUS** & GET

\$\$\$\$ OFF THE **XT-ELITE!**

XT-ELITE Includes 12-months updates

and SRS+ access

NEW HARDWARE / MORE POWER!

RESTART WARRANTY ON YOUR MOST USED MACHINE!

12 MONTHS UPDATES & SRS+ INCLUDED!



TRADE IN YOUR OLD KC100
at the same time & only pay
\$\$\$ for a new **KC100**

* 1X XTOOL-AUS CAN ONLY BE TRADED PER XT-ELITE TO REDEEM OFFER. OTHER MACHINES OF THE SAME VALUE OR MORE COULD BE USED TO REDEEM OFFER BUT ARE NOT GUARANTEED. SG LOCKS RESERVE THE RIGHT TO REFUSE ANY OFFER PUT FORWARD. CONTACT SALES FOR ANY FURTHER INFORMATION REQUIRED.

Art. ID
XT-ELITE-AUS



 LARGER ROM & RAM	 RICHER FUNCTIONALITY	 FASTER SPEED
 MILITARY GRADE TABLET	 2.5x BATTERY LIFE!	

Check sglocks.com.au

For Pricing!



WITH ANY SCAN TOOL TRADE-IN

Parameters

- CPU** Quad core processor 1.8GHz
- Memory** 2GB RAM, 64 GB ROM
- Touch screen** 8 inches LED Compatible touch screen
Resolution 1024*768 resolution
- Camera** Rear camera, 8 million pixels, with flash autofocus
- Sensor** Gravity sensor
- Interface** USB3.0,DC charging port,DB15 interface,MINI HDMI,
- Audio Input/Output** Microphone/Speaker
- Battery** 10000mAh 3.7V lithium polymer battery
- Working temperature** -20 to 50 degrees Celcius (-4 to 126 F)
- Relative humidity** <90%
- Appearance size** 275*183*33.9 (mm)

XTOOL

A U S T R A L I A

NEW

M822

- 'AKL' KIT

- FOR TOYOTA 'H' KEY 'BLADED'



NEW

M822



PRODUCT DESCRIPTION

XTOOL - TOYOTA 'H' KEY - ALL KEYS LOST SOLUTION !

No Dash removal required!

No limitation per use (unlimited access)

Comes with XTOOL KC+ SRS Access with Australian Market Instruction Manuals.



REQUIRED HARDWARE:

- XTOOL- Elite
- KS1 Emulator
- KC100

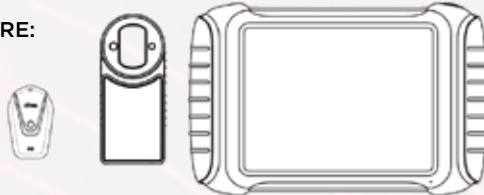

Art. ID
M822

Check

sglocks.com.au

For Pricing!

Toyota-H Vehicle Compatibility (OBD) :

- Camry ASV50R Altise 2015 2017
- Corolla ZRE182R Ascent 2012 2017
- Corolla ZRE182R Ascent Sport 2012 2017
- Corolla ZRE182R Levin SX 2012 2015
- Corolla ZRE182R RZ 2014 2014
- Corolla ZRE182R SX 2015 2017
- Hilux GGN120R SR 2015 2017
- Hilux GUN122R Workmate 2015 2017
- Hilux GUN123R SR 2015 2017
- Hilux GUN125R Workmate 2015 2017
- Hilux GUN126R SR 2015 2019
- Hilux GUN136R SR Hi-Rider 2015 2017
- Hilux TGN121R Workmate 2015 2017
- Hilux GUN126R Rugged 2018 2020
- Kluger GSU50R GX 2014 2016
- Kluger GSU50R GX 2016 2017
- Kluger GSU55R GX 2014 2016
- Kluger GSU55R GX 2016 2017
- RAV4 ALA49R GX 2012 2017
- RAV4 ALA49R GX 2015 2017
- RAV4 ASA44R GX 2012 2017
- RAV4 ZSA42R GX 2012 2017
- RAV4 ZSA42R GX 2012 2017
- + MORE



STEP-BY-STEP
easy to follow guides with
Large Images & Diagrams
per vehicle.

**SEE FULL COMPATIBILITY
& MANUALS ON SRS**

SPEND OVER \$990.00*
ON

sglocks.com.au

**In the one order
AND RECEIVE 1x FREE
PROMO ITEM**

Autoranging Multimeter

This practical multimeter measures both DC and AC voltages and currents. The default autoranging setting automatically selects the best range for your measurements. If a different range is preferred, simply switch it to manual. A built-in buzzer and LED warning light alert you to low resistance, detected voltage and live wires. In low light conditions you can activate the 10 second backlight to view measurements. Use the data hold button to lock them on screen for data capture and analysis.

- Continuity
- AC Current
- DC Current
- Resistance
- AC Voltage
- DC Voltage
- Data Hold
- Autorange
- Optical Sensor
- Length : 144mm
- Width : 70mm
- Height : 32mm
- Weight : 200g
- Plastic Casing
- Batteries included
- High Grade Meter Probe
- Protection Fuse
- Foldout Stand



* OCTOBER/NOVEMBER 2022 Promo " valid until 30th NOVEMBER 2022 or whilst stocks last.* Free Promotion item is only valid for online orders * Pricing shown excludes GST pricing as of 15/10/2022 and is subject to change. For most accurate pricing please check the SGLOCKS website.



Head Office
PH : 02 9352 0600
FAX: 02 9748 0566

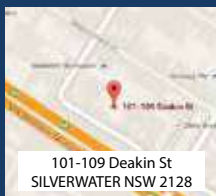

Colin McFarland
0491 445 005

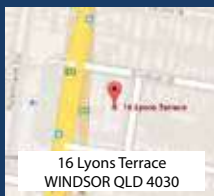

Vince Carson
0437 770 576

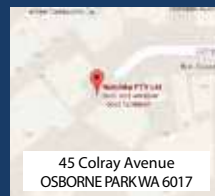

Jason Baker
0438 909 840

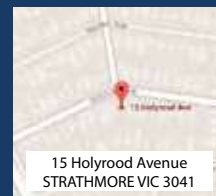

Henry Guldon
0400 613 714

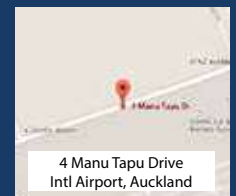

NZ Toll Free
0800 00 15 98

Your Sales Managers: