

SGLOCKS

Newsletter

APRIL 2022
ISSUE 92

MLAA
NATIONAL
ROADSHOW
WRAP UP

NEW



XTOOL
SPECIAL
UPGRADE
OFFER

NEW

LOCKTON
SMART LOCK
ELEV64

NEW



SGLOCK
& SECURITY

www.sglocks.com.au



SG 70
YEARS
Established 1951

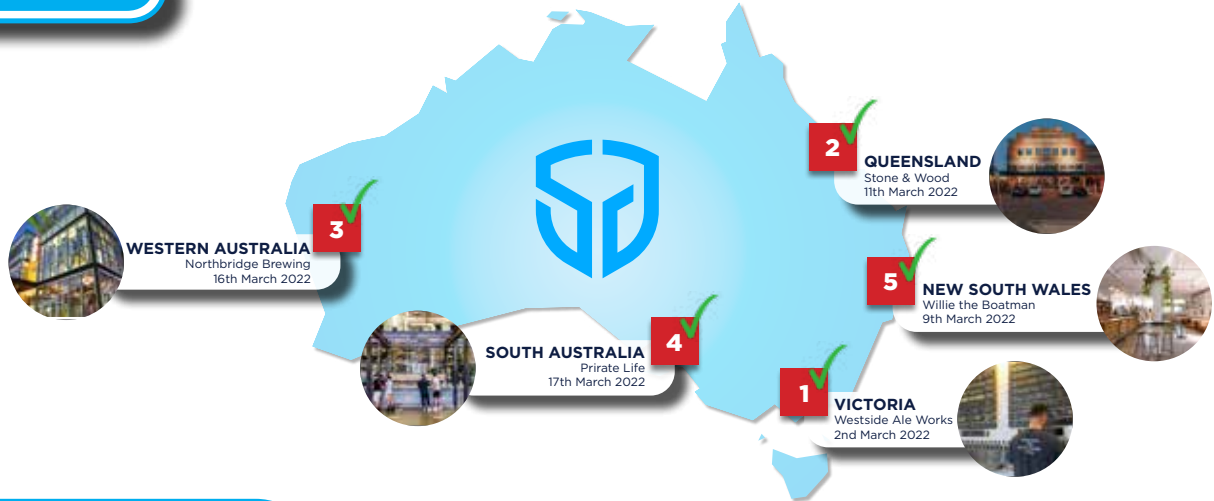

VIC

Over 100 customers and industry representatives came to the Victoria Meeting. The attendees indulged in the local craft beers & woodfired pizza.



Over 60 customers and industry representatives came to the Queensland Meeting. The attendees savoured the local craft beers, sliders and fingerfood.

QLD



WA

Over 50 customers and industry representatives came to the WA Meeting. The attendees tucked into the local beers, pizza and fingerfood.





MLAA NATIONAL ROADSHOW - WRAP UP

Over 40 customers and industry representatives came to the SA Meeting. The attendees enjoyed the craft beers & array of different fingerfood.



Over 60 customers and industry representatives came to the NSW Meeting. The attendees indulged in the local craft beers, chicken wings and bao buns.



At all events attendees honed their LISHI Skills, learnt more about SRS+ and were presented with both the ML20 Special Offer and the NEW LOCKTON Product Launch.

Winners are Grinner ! MLAA Lucky Door Prize Winners





NEW

Smart Door Lock

Art. **ELEV64**



Fingerprint



Digital
Password



APP



Key



Remote
Authorization



Smart Alarm



Battery
Powered



Emergency
Power Supply

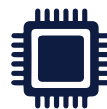

Powerful
CPU



Easy
Installation



The fingerprint sensing area is perfectly located on the lever to naturally read a thumb print for quick entry & can store up to 100 x individual fingerprints



Emergency Key Override



Pin Code touch pad with ability to store 100 x Individual User Codes (permanent or temporary)



Battery Life 12 months or Approximately 10,000 x Openings



Use and Manage the ELEV64 via Phone App. Open the Lock, Add Users, Issue Temporary Codes + Lots More





ELEV64 can easily be fitted in place of most Knobsets, Leversets or Deadbolts. Additional Scar plates can be purchased to fit ELEV64 in place of a large range of other locks found in the Australian Market.

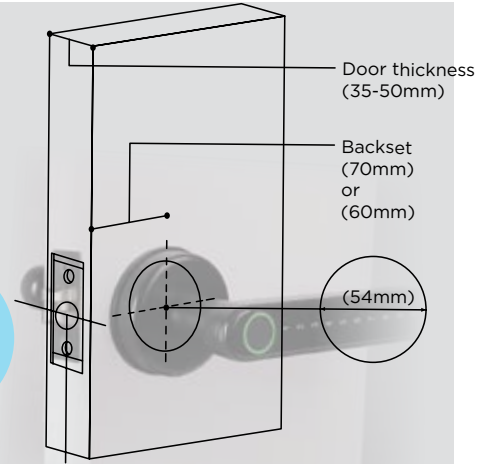

ELEV64 - APP / ADMIN FUNCTIONS

- Manage eKeys, Passcodes & Fingerprints all from within the APP
- Review Access Logs in Timeline order
- Receive 'UNLOCK' Notifications instantly
- Update the Firmware on your locks

+ Setup & Send Unlimited eKeys

Grant or Revoke Access with E-Keys. E-Keys can be Time/Period Based, Permanent, One Time, Cyclic or Customised



E-KEY / PASSCODE TYPES	EXAMPLE USER
Permanent Passcode	Owner / Administrator
Timed Passcode	Short term stays , Air BNB
One-Time Passcode	Maintenance or Delivery to property
Custom Passcode	For Family & Friends
Recurring Passcode	Baby sitter, House cleaner



ELEV64 - G2-GATE

G2 GATE is a WiFi Bridge that extends the functionality of your E-Series locks by giving the administrator Control to access remotely, from anywhere in the world!



LOCKTON 'E-Series' SMART DOOR LOCK - ELEV64



Check
sglocks.com.au
For Pricing!



Check
sglocks.com.au
For Pricing!

PRODUCT DESCRIPTION

- LOCKTON 'E-Series' Smart Door Lock supports:
- Fingerprints
 - Digital PIN Codes
 - Mobile App functionality.
 - Suitable for Domestic and Office applications.
 - Retrofits most residential and commercial Knobsets and Leversets.
 - Optional G2 Gateway accessory allows for Remote access and control of lock via WiFi.

PRODUCT SPECIFICATIONS

- Finish: Black or Silver
- Suitable door thickness: 35 - 50 mm
- Adjustable 60/70 mm Backset Latch
- Power Supply: 4 x AAA Alkaline Batteries
- Battery Life: Approx. 10,000 openings
- Safe Working Temperature: -20 to 50 Degrees Celsius

LOCKTON 'E-Series' WI-FI BRIDGE - G2 Gateway



Check
sglocks.com.au
For Pricing!

PRODUCT DESCRIPTION

Optional Gateway designed to suit LOCKTON ELEV64 Smartlock. The G2-GATE enables communication with your Smartlock via Wi-Fi, allowing you to Change PIN Codes, Add Fingerprints, Create Temporary PIN Codes, Review Audit Trails and other management tasks from anywhere with an Internet connection via the TT Lock App.

PRODUCT SPECIFICATIONS

- Dimensions: 70 x 70 x 26 mm
- Network: WiFi 2.4G
- IEEE Standard: 802.11 b/g/n
- Power Connection: Type C USB
- Power Input: 5V/500mA

LOCKTON Spare OVERRIDE KEY - Suits Art. ELEV64 Smart Locks



Art ID. *ELEV-KEYBLANK*

Check
sglocks.com.au
For Pricing!

PRODUCT DESCRIPTION

Spare Override Key Blank to suit LOCKTON 'E-Series' ELEV64 Smart Lock.

PRODUCT SPECIFICATIONS

- Suits: ELEV64 Smart Lock
- Material: Chrome Plated Brass



NEW

LOCKTON 'E-Series' ELEV64 Display stand

PRODUCT DESCRIPTION:

LOCKTON E-SERIES Display Stand. Fitted with Art. ELEV64-BLK.

This Display Stand comes complete with fully functioning ELEV64 Smart Door Lock. It is the best way to showcase this Lock in your shop.

PRODUCT SPECIFICATION :

- Height: 345 mm
- Width: 190 mm
- Depth: 190 mm
- Stand Colour: Enamelled White
- Header Card: Blue LOCKTON E-Series

Display Stand supplied FREE with Dealer Package Scan for more details



Art. ELEV64-DISP

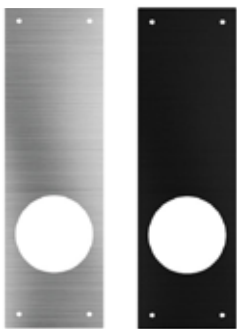

NEW

LOCKTON - SCAR PLATE (RECTANGLE 225x69mm) - CUT-OUT: Round 54mm Dia.

PRODUCT DESCRIPTION:

This LOCKTON Scar Plate is designed to patch and cover-up drill holes and installation points on a variety of domestic entry locksets (see compatibility below).

This plate is also designed to retrofit the LOCKTON Art. ELEV64 to provide a neat and well presented installation.

PRODUCT SPECIFICATION :

- Dimensions (L X W X T): 225 x 69 x 1.2mm
- Hole Cut-out Diameter: 54mm
- Pack Quantity: 1 x Plate
- Compatibility: Gainsborough Trilock, Lockwood Nexion and Lane Corvan

Art. PS-REC-TNC-SS

Art. PS-REC-TNC-SS-BLK



NEW

LOCKTON - SCAR PLATE (ROUND 75mm Dia.) - CUT-OUT: Round 54mm Dia.

PRODUCT DESCRIPTION:

This LOCKTON Scar Plate is designed to patch and cover-up drill holes and installation points on a variety of domestic entry locksets (see compatibility below).

This plate is also designed to retrofit the LOCKTON Art. ELEV64 to provide a neat and well presented installation.

PRODUCT SPECIFICATION :

- Plate Diameter: 75mm
- Thickness: 1.2mm
- Hole Cut-Out Diameter: 54mm
- Pack Quantity: 1 x Plate

Art. PS-RND-75-SS

Art. PS-RND-75-SS-BLK



NEW

LOCKTON - SCAR PLATE (ROUND 85mm Dia.) - CUT-OUT: Round 54mm Dia.

PRODUCT DESCRIPTION:

This LOCKTON Scar Plate is designed to patch and cover-up drill holes and installation points on a variety of domestic entry locksets (see compatibility below).

This plate is also designed to retrofit the LOCKTON Art. ELEV64 to provide a neat and well presented installation.

PRODUCT SPECIFICATION :

- Plate Diameter: 85mm
- Thickness: 1.2mm
- Hole Cut-out Diameter: 54mm
- Pack Quantity: 1 x Plate

Art. PS-RND-85-SS

Art. PS-RND-85-SS-BLK

NEW



Art.
790-90

'Keyed' FOLDING BIKE LOCK - 90cm Long

PRODUCT DESCRIPTION:

- Hardened steel elements
- Completely covered with plastic to protect the frame
- Including frame holder. Mounting with screws or cable ties
- Drill-proof cylinder lock
- Supplied with 2 keys
- Suitable for bicycles, mopeds and motorcycles

PRODUCT SPECIFICATIONS:

- Length : 90cm
- Thickness : 8.5mm
- Width of Chain : 26mm
- Weight : 1.29kg

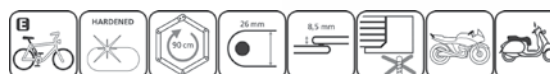

NEW



Art.
610-53

'Scan & Lock' 53mm PADLOCK - CARDED

PRODUCT DESCRIPTION:

- BURG WÄCHTER Scan & Lock padlock with finger print scan.
- Suitable for indoor and outdoor (IP65) use and up to 10 individual users / finger prints.
- Great for personal lockers, cellar and garden shed doors. Also ideal for use in office and food service environments.

PRODUCT SPECIFICATIONS:

- Hardened steel shackle
- Up to 10 fingerprints can be saved
- Weatherproof, protection class IP 65
- Includes charging cable and 2 emergency keys
- Low Battery warning
- Lock Width : 53mm
- Shackle Diameter : 5mm
- Shackle Width : 12mm
- Shackle Height : 27mm
- Weight : 0.26kg

IDEAL FOR:

- Wine Cellars
- Garden Sheds
- Offices
- Food Service



NEW

'Keyed' DISC BRAKE LOCK - 100cm Long



Art.
520-50

PRODUCT DESCRIPTION:

- Hardened steel
- For securing motorcycles, e-bikes, mopeds and e-scooters.
- Suitable for models with disc brakes
- Striking neon yellow
- Supplied with two keys and a practical storage bag



PRODUCT SPECIFICATIONS:

- Length : 100cm
- Shackle Diameter : 5.4mm
- Weight : 190g





VERIFY YOUR ORIGINAL LISHI TOOLS



ORIGINAL LISHI

'Lishi' DOMESTIC STARTER KIT -

Includes 3 x Popular Domestic Lishi Picks

PRODUCT DESCRIPTION:

The LP-KIT-DOM-START LISHI Pick Starter Kit, is the ideal kit for anyone getting into domestic LISHI picking and decoding.

The kit contains 3 x of the most popular domestic pick and decoders, making it perfect for beginners or experienced people.

KIT CONTAINS Art.

1	LP-LW5-AG
2	LP-LW4-AG
3	LP-TE2-AG
4 Position Protective Case	LP-PC x 3



Art. LP-KIT-DOM-START



SCAN for more information on this Kit



VERIFY YOUR ORIGINAL LISHI TOOLS



ORIGINAL LISHI

'Lishi' DOMESTIC ADVANCED KIT -

Includes 8 x Popular Domestic Lishi Picks

PRODUCT DESCRIPTION:

The LP-KIT-DOM-ADV LISHI Pick Advanced Kit, is the ideal kit for the professional domestic locksmithing specialist.

The kit contains 8 x of the most popular domestic pick and decoders, making it perfect for experienced people.

KIT CONTAINS Art.

1	LP-LW5-AG	6	LP-SC1-AG
2	LP-LW4-AG	7	LP-KW1-AG
3	LP-TE2-AG	8	LP-KW5-AG
4	LP-TE2-AG	4 Position Protective Case	LP-PC x 8
5	LP-SC4-AG		



Art. LP-KIT-DOM-ADV



SCAN for more information on this Kit

ORIGINAL LISHI

Auto. Pick - APRILIA/DUCATI/YAMAHA/ZADI - Suits Keyways (ZD24R)

PRODUCT DESCRIPTION

ORIGINAL LISHI have an extremely high quality control and manufacturing processes to help ensure that each ORIGINAL LISHI Tool withstands the rigors of daily use and still provides years of service.

ORIGINAL LISHI Tools are guaranteed to do what they are designed to do, all ORIGINAL LISHI Tools are supplied with a verification code on the back of the pick.

This code can be validated to ensure you are trusting your business to; the Original / the Best : ORIGINAL LISHI

PRODUCT SPECIFICATION

- Lock Profile: ZA-4D (ZD24R) APRILIA/DUCATI/YAMAHA/ZADI
- Tool Type: 2-in-1 Pick & Decoder
- Compatibility: IGNITION only
- Finish: Anti-Glare
- IC Card: 224

VERIFY YOUR ORIGINAL LISHI TOOLS



Art. LP-ZD24R-AG

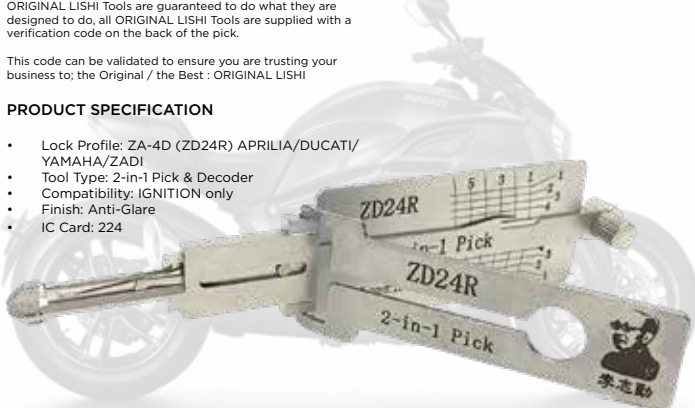

ORIGINAL LISHI

Auto. Pick - JEEP - Suits Keyways (CY24R) 2021+ W/Smart Entry

Anti - Glare

PRODUCT DESCRIPTION

ORIGINAL LISHI have an extremely high quality control and manufacturing processes to help ensure that each ORIGINAL LISHI Tool withstands the rigors of daily use and still provides years of service.

ORIGINAL LISHI Tools are guaranteed to do what they are designed to do, all ORIGINAL LISHI Tools are supplied with a verification code on the back of the pick.

This code can be validated to ensure you are trusting your business to; the Original / the Best : ORIGINAL LISHI

PRODUCT SPECIFICATION

- Lock Profile: CY24R (JEEP - 2021+ With Smart Entry)
- Tool Type: 2-in-1 Pick & Decode
- Compatibility: DOOR Only
- Finish: Anti-Glare
- Suits: Wrangler & Grand Cherokee Models 2021+ (W/ Smart entry)

VERIFY YOUR ORIGINAL LISHI TOOLS



Art. LP-CY24R-2021-AG

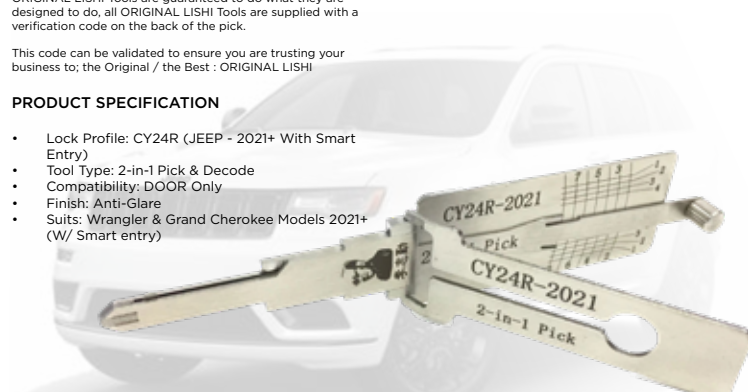



Art. **E964M**

MERLIN 'MERLIN' - Car Visor - 4-Channel

PRODUCT DESCRIPTION
Capable of coding both Merlin+ and Merlin+ 2.0 Motors
Controls up to four different doors or gates
Rolling code

PRODUCT SPECIFICATION

Number of Buttons: 4
Battery: CR2032
Colour: Grey
Car Visor Clip Included
Frequency: 434.54 MHz
Suits models: Commander Essential (MS65MYQ), Commander Elite (MS105MYQ), Commander Extreme (MS125MYQ), SilentDrive™ Essential (MR655MYQ), SilentDrive™ Elite (MR855MYQ), Commander Ultimate (MJ3800MYQ), Commander MyQ, WhisperDrive, TiltMaster, PowerAce, CyclonePro, OverDrive, SilentDrive Elite MyQ, SilentDrive BBU, SilentDrive Pro, QuietDrive Pro, WeatherDrive, MJ3800BBU, MT800, MT600, MT1000, MT3850, MT5580P, MT60P, MT60, MT230, RollerAce (MR60), MR600, MR800, MR1000, MJ3800, MJ3800R and all other Merlin garage door opener manufactured since 2009



Art. **E970M**

MERLIN 'MERLIN' - FOB - 4-Channel

PRODUCT DESCRIPTION
Capable of Coding Both Merlin+ and Merlin+ 2.0 Motors
Controls up to four different doors or gates
Compatible with E950M & C945
Rolling code

PRODUCT SPECIFICATION

Number of Buttons: 4
Battery: CR2032
Colour: Grey body, Green buttons
Frequency: 434.54MHz
Suits models: Commander Essential (MS65MYQ), Commander Elite (MS105MYQ), Commander Extreme (MS125MYQ), SilentDrive™ Essential (MR655MYQ), SilentDrive™ Elite (MR855MYQ), Commander Ultimate (MJ3800MYQ), Commander MyQ, WhisperDrive, TiltMaster, PowerAce, CyclonePro, OverDrive, SilentDrive Elite MyQ, SilentDrive BBU, SilentDrive Pro, QuietDrive Pro, WeatherDrive, MJ3800BBU, MT800, MT600, MT1000, MT3850, MT5580P, MT60P, MT60, MT230, RollerAce (MR60), MR600, MR800, MR1000, MJ3800, MJ3800R and all other Merlin garage door opener manufactured since 2009



Art. **E980M**

MERLIN 'MERLIN' - FOB - Water Resistant - 4-Channel

PRODUCT DESCRIPTION
Capable of coding both Merlin+ and Merlin+ 2.0 Motors
Water and Dust resistant - IP65
Controls up to four different doors or gates
Compatible with E950M & C945
Rolling code

PRODUCT SPECIFICATION

Number of buttons: 4
Battery: CR2032
Colour: Grey body, Green buttons
Frequency: 434.54 MHz
Suits models: Commander Essential (MS65MYQ), Commander Elite (MS105MYQ), Commander Extreme (MS125MYQ), SilentDrive™ Essential (MR655MYQ), SilentDrive™ Elite (MR855MYQ), Commander Ultimate (MJ3800MYQ), Commander MyQ, WhisperDrive, TiltMaster, PowerAce, CyclonePro, OverDrive, SilentDrive Elite MyQ, SilentDrive BBU, SilentDrive Pro, QuietDrive Pro, WeatherDrive, MJ3800BBU, MT800, MT600, MT1000, MT3850, MT5580P, MT60P, MT60, MT230, RollerAce (MR60), MR600, MR800, MR1000, MJ3800, MJ3800R and all other Merlin garage door opener manufactured since 2009



SCAN TO SEE THE FULL
GARAGE & GATE RANGE ON
sglocks.com.au

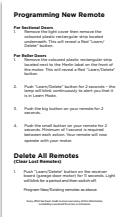

ALL REMOTES INCLUDE

All Remotes come individually packaged with the following information:

- **Remote Compatibility**
Shows range of remotes it can replace
- **Programming Instructions**
Done by customer in front of Garage/Gate
- **Barcode Included**
All remotes are barcoded

WARNING
THIS PRODUCT CONTAINS A BUTTON BATTERY
If swallowed, a lithium button battery can cause severe or fatal injuries within 2 hours.
Keep batteries out of reach of children.
If you think batteries may have been swallowed or placed inside any part of the body, seek immediate medical attention.

XTOOL

A U S T R A L I A

**TRADE
IN DEAL**

UPGRADE & SAVE!



TRADE IN YOUR OLD **XTOOL-AUS** & GET

\$1150 OFF THE **XT-ELITE!**

XT-ELITE Includes 12-months updates

and SRS+ access = Worth **\$490**

NEW HARDWARE / MORE POWER!

RESTART WARRANTY ON YOUR MOST USED MACHINE!

12 MONTHS UPDATES & SRS+ INCLUDED!



TRADE IN YOUR OLD KC100
at the same time & get a
big discount on a new unit

* 1X XTOOL-AUS CAN ONLY BE TRADED PER XT-ELITE TO REDEEM OFFER. OTHER MACHINES OF THE SAME VALUE OR MORE COULD BE USED TO REDEEM OFFER BUT ARE NOT GUARANTEED. SG LOCKS RESERVE THE RIGHT TO REFUSE ANY OFFER PUT FORWARD. CONTACT SALES FOR ANY FURTHER INFORMATION REQUIRED.

Art. ID
XT-ELITE-AUS



LARGER
ROM & RAM

RICHER
FUNCTIONALITY

FASTER
SPEED

MILITARY
GRADE
TABLET

2.5X
BATTERY LIFE!

Ex Gst



Check

 sglocks.com.au 

For Pricing!

Parameters

CPU Quad core processor 1.8GHz

Memory 2GB RAM, 64 GB ROM

Touch screen 8 inches LED Compatible touch screen
Resolution 1024*768 resolution

Camera Rear camera, 8 million pixels, with flash autofocus

Sensor Gravity sensor

Interface USB3.0,DC charging port,DB15 interface,MINI HDMI,

Audio Input/Output Microphone/Speaker

Battery 10000mAh 3.7V lithium polymer battery

Working temperature -20 to 50 degrees Celcius (-4 to 126 F)

Relative humidity <90%

Appearance size 275*183*33.9 (mm)



Art. **PPP-SET-SS**

NEW

LOCKTON
S/Steel PULL & PUSH PLATE SET (300mm x 100mm)

PRODUCT DESCRIPTION:

LOCKTON PPP-SET-SS - Contains one of each Stainless Steel "Push" Plate & "Pull" Plate. Fixing holes on each plate allows handles to be mounted either back to back or at different heights if needed. Supplied in a box with fixing screws. Often also used to cover existing holes & or damage to doors.

PRODUCT SPECIFICATION :

- Material: Stainless Steel
- Dimensions: 300 mm x 100 mm x 1.5 mm each
- 19mm Diameter Pull Handle
- Fixing Screws provided
- Pack Quantity: 2 x Plates (1 x Push, 1 x Pull)



Art. **PPP-PULL-SS**

NEW

LOCKTON
S/Steel PULL PLATE with Handle (300mm x 100mm)

PRODUCT DESCRIPTION:

LOCKTON PPP-PULL-SS - Stainless Steel "Pull" Plate.

PRODUCT SPECIFICATION :

- Material: Stainless Steel
- Dimensions: 300 mm x 100 mm x 1.5 mm
- 19mm Diameter Pull Handle
- Often also used to cover existing holes & or damage to doors.
- Pack Quantity: 1 x Plate



Art. **PPP-PUSH-SS**

NEW

LOCKTON
S/Steel PUSH PLATE (300mm x 100mm)

PRODUCT DESCRIPTION:

LOCKTON PPP-PUSH-SS - Stainless Steel "Push" Plate

PRODUCT SPECIFICATION :

- Material: Stainless Steel
- Dimensions: 300 mm x 100 mm x 1.5 mm
- Often also used to cover existing holes & or damage to doors
- Pack Quantity: 1 x Plate



Art. **ML60-RBKIT**

NEW

LOCKTON
REBATE KIT - Suits LOCKTON ML60 range of Mortice Locks

PRODUCT DESCRIPTION:

The "ML60-RBKIT" Rebate kit is designed to suit LOCKTON ML60 Mortice Locks. It allows these locks to be installed in rebated doors. May also be suitable for "other brand" Mortice Locks

PRODUCT SPECIFICATION :

- 2 x Timber Fixing Screws
- 1 x Strike Plate
- 1 x Strike
- Suit 13mm rebate



Art. **ML60-FABKIT**

NEW

LOCKTON
FABRICATOR KIT- Suits LOCKTON ML60 range of Mortice Locks

PRODUCT DESCRIPTION:

The LOCKTON Art. ML60-FABKIT fabricator kit is designed to suit LOCKTON ML60 Mortice Locks. It allows these locks to be installed in aluminium frames large enough to accept these larger mortice locks. May also be suitable for "Other Brand" Mortice Locks.

PRODUCT SPECIFICATION :

- 2 x Fitting plates for the mortice lock
- 1 x Strike Plate
- 1 x Strike Box
- 4x M4 x 8 MM Screws
- 2 x M4 x 12mm screws



NEW CATALOGUE



2022

**SEE THE NEW
LOCKTON CATALOGUE
INCLUDED IN
THIS MONTH'S
NEWSLETTER**





OR

OR

SPEND OVER \$1190.00.00*
ON

sglocks.com.au

**In the one order
AND RECEIVE YOUR
CHOICE FREE**



"APRIL 2022 Promo" valid until 30th APRIL 2022 or whilst stocks last.
* Free Promotion item is only valid for online orders * Pricing shown excludes GST
pricing as of 1/4/2022 and is subject to change. For most accurate pricing please check the sglocks website.



Head Office
PH : 02 9352 0600
FAX: 02 9748 0566

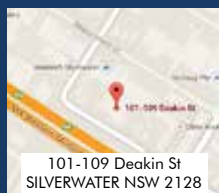

Colin McFarland
0491 445 005

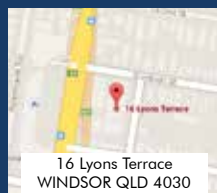

Vince Carson
0437 770 576

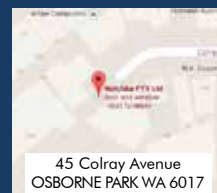

Jason Baker
0438 909 840

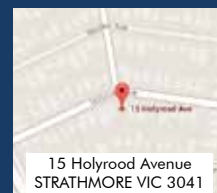

Henry Guldon
0400 613 714

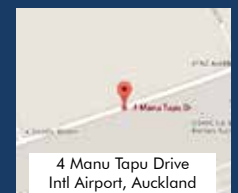

NZ Toll Free
0800 00 15 98

**Your Sales
Managers:**